



**> felo**  
BIT RANGE

## Bithalter & Adapter Bitholder & Adapters

### 038

#### Bithalter E 6,3 mit Magnet

*Bitholder E 6,3 with magnet*



					Art.-Nr.		EAN-Code
<b>Bithalter E 6,3 mit Magnet, extra stark</b> / <i>Bitholder E 6,3 with magnet, extra strong</i>							
	47 mm	E 6,3	1/4"	6	<b>038 109 90</b>	17	40 07157 30850 4
<b>Bithalter E 6,3 mit Magnet</b> / <i>Bitholder E 6,3 with magnet</i>							
	58 mm	E 6,3	1/4"	6	<b>038 103 90</b>	22	40 07157 30340 0
<b>dto. in Blister</b> / <i>blistered</i>				10	<b>038 103 96</b>	30	40 07157 10288 1
<b>Bithalter E 6,3 mit Magnet und Sprengring</b> / <i>Bitholder E 6,3 with magnet and retaining ring</i>							
	74 mm	E 6,3	1/4"	6	<b>038 102 90</b>	30	40 07157 30337 0
<b>Bithalter E 6,3 mit Magnet und Sprengring</b> / <i>Bitholder E 6,3 with magnet and retaining ring</i>							
	100 mm	E 6,3	1/4"	6	<b>038 105 90</b>	31	40 07157 50458 6
<b>Bithalter E 6,3 mit Magnet und Sprengring</b> / <i>Bitholder E 6,3 with magnet and retaining ring</i>							
	150 mm	E 6,3	1/4"	6	<b>038 107 90</b>	44	40 07157 50464 7
<b>Bithalter E 6,3 mit Magnet und Sprengring</b> / <i>Bitholder E 6,3 with magnet and retaining ring</i>							
	200 mm	E 6,3	1/4"	6	<b>038 108 90</b>	60	40 0715 763945 5

### 037

#### Bithalter E 6,3 QuickLock

*Bitholder E 6,3 QuickLock*



					Art.-Nr.		EAN-Code
	51 mm	E 6,3	1/4"	6	<b>037 103 90</b>	25	40 07157 32146 6

### 059

#### Bithalter E 6,3 mit Tiefenanschlag inkl. PH 2 Bit

*Bitholder E 6,3 with depth stop  
incl. PH 2 Bit*



					Art.-Nr.		EAN-Code
	max. 79 mm	E 6,3	1/4"	6	<b>059 103 90</b>	74	40 07157 51897 2

### 018

#### Bithalter A 5,5 mit Magnet

*Bitholder A 5,5 with magnet*



					Art.-Nr.		EAN-Code
	60 mm	A 5,5	1/4"	6	<b>018 102 90</b>	30	40 07157 30043 0

# 048

## Bithalter G 7 mit Magnet und Sprengring

*Bitholder G 7 with magnet and retaining ring*



				Art.-Nr.		EAN-Code
60 mm	G7	1/4"	6	<b>048 102 80</b>	31	40 07157 32452 8

# 058

## Bithalter SDS mit Magnet

*Bitholder SDS with magnet*



				Art.-Nr.		EAN-Code
98 mm	SDS	1/4"	6	<b>058 102 90</b>	58	40 07157 30978 5

# 097

## Adapter A 5,5

*Adapter A 5,5*



				Art.-Nr.		EAN-Code
50 mm	A 5,5	1/4"	6	<b>097 011 10</b>	15	40 07157 30479 7

# 097

## Adapter E 6,3

*Adapter E 6,3*



				Art.-Nr.		EAN-Code
50 mm	E 6,3	1/4"	6	<b>097 013 10</b>	15	40 07157 30481 0

# 097

## Adapter E 6,3

*Adapter E 6,3*



				Art.-Nr.		EAN-Code
50 mm	E 6,3	3/8"	6	<b>097 020 10</b>	23	40 07157 30489 6



## 4 IMPACT

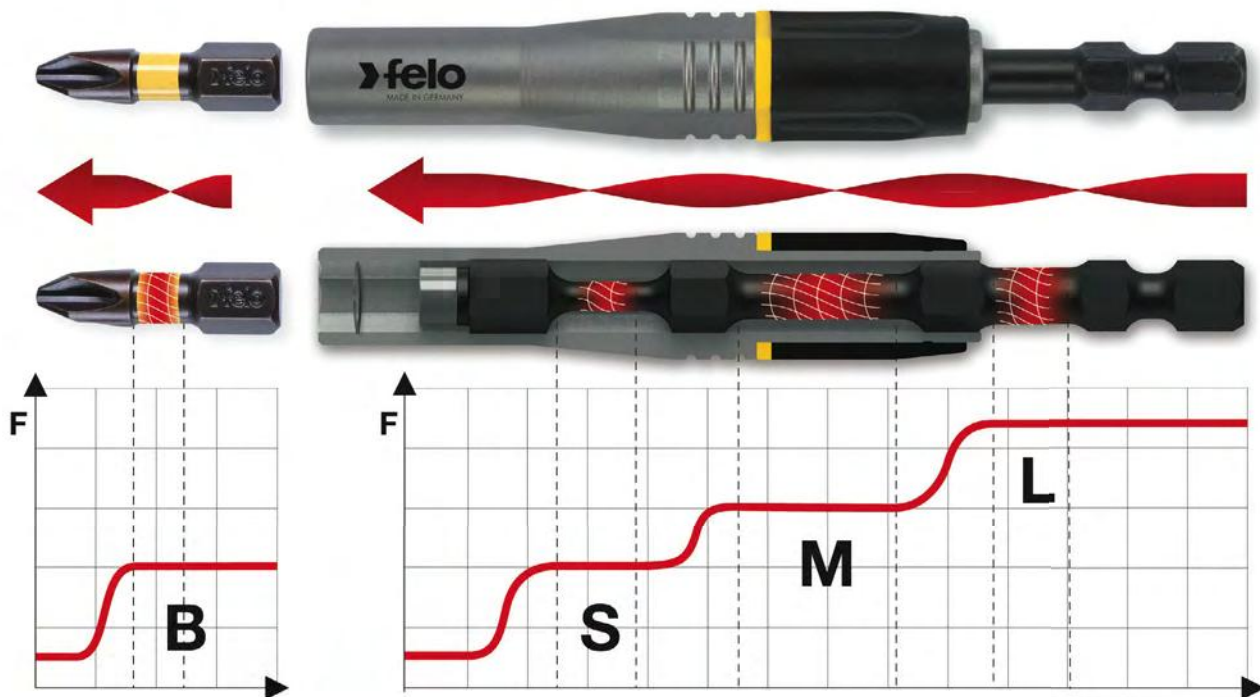

### 4 IMPACT

- S-M-L Dämpfungs-Kaskade für einen weiteren Drehmoment-Bereich (z.B. PH1 - PH3).
- Synchronisierte Torsionszonen lösen bei steigenden Momenten (Impulsen) in Folge aus und absorbieren die Drehmomente-Stöße.
- Zusätzliche 4. Dämpfungsstufe bei Einsatz mit Felo IMPACT Bits.
- Speziell entwickelt für den Einsatz in Tangential-Schlagschraubern.
- Mit Sprengring.

### 4 IMPACT

- S-M-L absorption cascade for a wide torque range (e.g. PH1 - PH3).
- Synchronized torsion-zones are sequentially triggered at increasing torque impulses and absorb torque peaks.
- Additional 4th absorption step when used with Felo IMPACT bits.
- Specially developed to be used with tangential impact drivers.
- With retaining ring.

**038**  
**E 6,3**

**IMPACT Bithalter**  
IMPACT Bitholder



95 mm

E 6,3

6

Art.-Nr.

**038 295 90**



43

EAN-Code

40 07157 63337 8

**038**  
**E 6,3**

**IMPACT Bithalter in Blister**  
IMPACT Bitholder blistered



95 mm

E 6,3

6

Art.-Nr.

**038 295 94**



53

EAN-Code

40 07157 63077 3

**Der Hochleistungs-Bit • nimmt Drehmomentstöße auf • verlängert wesentlich die Standzeiten • reduziert die Anpresskräfte**

*The high performance bit • absorbs torque peaks • substantially extends tool life • reduces contact pressure*

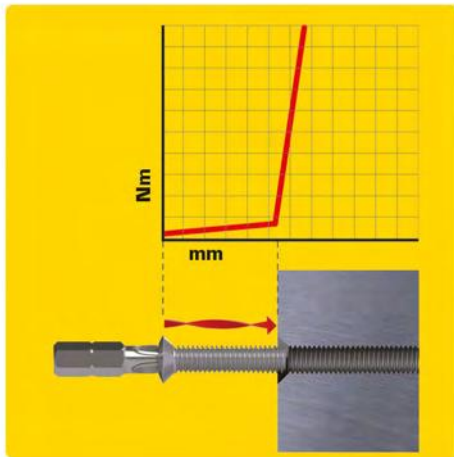

### Harter Schraubfall

#### Problem:

Beim Aufsetzen des Schraubenkopfs entsteht schlagartig eine Drehmomentspitze, welche Schraube und Bit beschädigen kann.

#### Lösung:

Felo IMPACT Bits absorbieren Drehmoment Spitzen und verhindern wirkungsvoll Beschädigungen.

### Hard screw joint

#### Problem:

The sudden torque peak occurring when the screw head hits the surface of the work piece can damage screw and bit.

#### Solution:

Felo IMPACT bits absorb torque peaks and effectively prevent damage.

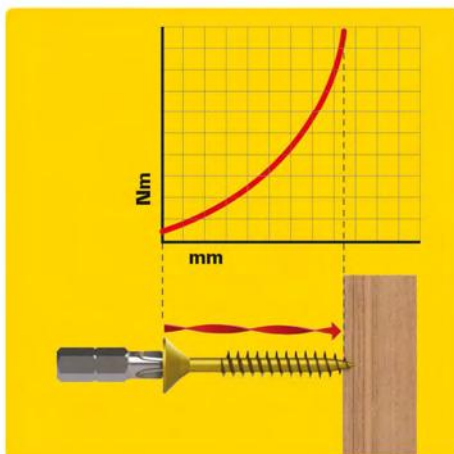

### Weicher Schraubfall

z.B. Verschraubungen in Holz, bei denen das Drehmoment kontinuierlich ansteigt.

#### Zusätzlicher Vorteil:

Besonders verschleißfeste Profile erhöhen die Lebensdauer des Bits.

### Soft screw joint

e.g. fastening screws into wood, with torque steadily increasing along the way.

#### Extra advantage:

Especially wear-resistant profiles increase life span of the bits.



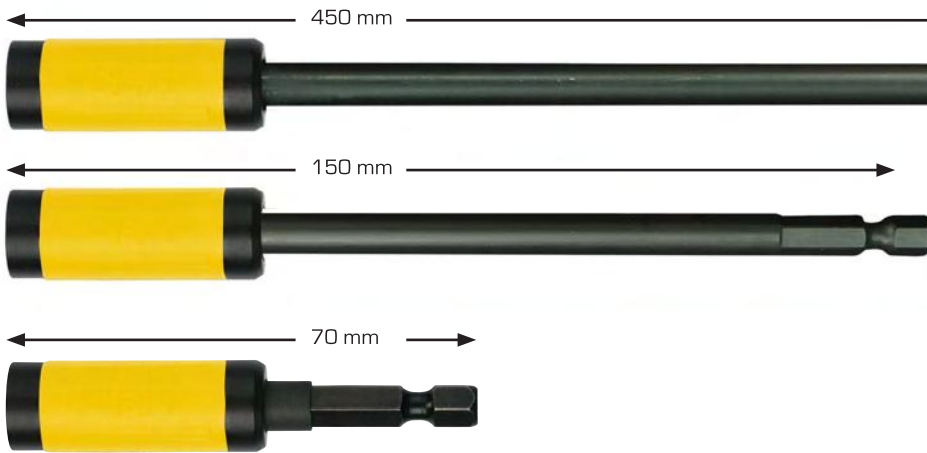

Der Felo Star Automatikhalter sorgt durch seinen federelagerten Ringmagnet für einen sicheren Halt der Schraube. Durch die bewegliche Hülse des Bithalters passt sich der Bit der Tiefe des Schraubkopfes an und ermöglicht so perfekte Schraubergebnisse ohne Festhalten der Schraube mit der Hand. Hochwertige Materialien garantieren eine hohe Lebensdauer.

The spring loaded movable sleeve of Felo Star automatic holder carries a strong ring magnet that pulls the head of the screw tightly onto the tip of the bit, eliminating the need to manually position the screw. This achieves extra safety and perfect work results. High quality materials and precise machining guarantee a long tool life.

### 038

Star Bithalter  
Star Bitholder



					Art.-Nr.		EAN-Code
	70 mm	E 6,3	1/4"	6	<b>038 165 90</b>	31	40 07157 50799 0
<b>Star Bithalter in Blister / Star Bitholder blistered</b>							
	70 mm	E 6,3	1/4"	6	<b>038 165 94</b>	37	40 07157 52673 1
	150 mm	E 6,3	1/4"	6	<b>038 169 90</b>	55	40 07157 51979 5
	450 mm	E 6,3	1/4"	1	<b>038 170 90</b>	128	40 07157 60367 8

# Industrie Bits





## Industrial Bit



**020**  
**C 6,3**

**Industrie Bit C 6,3 Schlitz**  
*Industrial Bit C 6,3 Slotted*







				Art.-Nr.		EAN-Code	
<b>3,0 x 0,5</b>	25 mm	C 6,3	1/4"	10	<b>020 300 10</b>	4	40 07157 30066 9
<b>3,5 x 0,6</b>	25 mm	C 6,3	1/4"	10	<b>020 310 10</b>	4	40 07157 30070 6
<b>4,0 x 0,8</b>	25 mm	C 6,3	1/4"	10	<b>020 410 10</b>	5	40 07157 30079 9
<b>5,5 x 1,0</b>	25 mm	C 6,3	1/4"	10	<b>020 520 10</b>	5	40 07157 30105 5
<b>6,5 x 1,2</b>	25 mm	C 6,3	1/4"	10	<b>020 610 10</b>	6	40 07157 30119 2
<b>8,0 x 1,2</b>	25 mm	C 6,3	1/4"	10	<b>020 800 10</b>	7	40 07157 30918 1

**021**  
**C 6,3**

**Industrie Bit C 6,3 Pozidriv**  
*Industrial Bit C 6,3 Pozidriv*







<b>PZ</b>				Art.-Nr.		EAN-Code	
<b>0</b>	25 mm	C 6,3	1/4"	10	<b>021 000 10</b>	4	40 07157 24025 5
<b>1</b>	25 mm	C 6,3	1/4"	10	<b>021 010 10</b>	5	40 07157 30159 8
<b>1 (VE 100)</b>	25 mm	C 6,3	1/4"	100	<b>021 010 17</b>	500	40 07157 30925 9
<b>2</b>	25 mm	C 6,3	1/4"	10	<b>021 020 10</b>	5	40 07157 30169 7
<b>2 (VE 100)</b>	25 mm	C 6,3	1/4"	100	<b>021 020 17</b>	520	40 07157 30928 0
<b>3</b>	25 mm	C 6,3	1/4"	10	<b>021 030 10</b>	6	40 07157 30180 2
<b>3 (VE 100)</b>	25 mm	C 6,3	1/4"	100	<b>021 030 17</b>	540	40 07157 31353 9
<b>4</b>	32 mm	C 6,3	1/4"	10	<b>021 042 10</b>	12	40 07157 30190 1

**022**  
**C 6,3**

**Industrie Bit C 6,3 Phillips**  
*Industrial Bit C 6,3 Phillips*



<b>PH</b>				Art.-Nr.		EAN-Code	
<b>0</b>	25 mm	C 6,3	1/4"	10	<b>022 000 10</b>	4	40 07157 30937 2
<b>1</b>	25 mm	C 6,3	1/4"	10	<b>022 010 10</b>	5	40 07157 30193 2
<b>1 (VE 100)</b>	25 mm	C 6,3	1/4"	100	<b>022 010 17</b>	470	40 07157 30940 2
<b>2</b>	25 mm	C 6,3	1/4"	10	<b>022 020 10</b>	5	40 07157 30205 2
<b>2 (VE 100)</b>	25 mm	C 6,3	1/4"	100	<b>022 020 17</b>	510	40 07157 30943 3
<b>3</b>	25 mm	C 6,3	1/4"	10	<b>022 030 10</b>	6	40 07157 30218 2
<b>3 (VE 100)</b>	25 mm	C 6,3	1/4"	100	<b>022 030 17</b>	560	40 07157 31351 5
<b>4</b>	32 mm	C 6,3	1/4"	10	<b>022 042 10</b>	11	40 07157 30229 8





**022**  
**C 6,3**

**Industrie Bit C 6,3 Phillips „Grabber“**  
*Industrial Bit C 6,3 Phillips "Grabber"*



**extra slim**



<b>PH</b>				Art.-Nr.		EAN-Code	
<b>2</b>	25 mm	C 6,3	1/4"	10	<b>022 002 10</b>	4	40 07157 10238 6

## 024 C 6,3



**Industrie Bit C 6,3 Sechskant**  
*Industrial Bit C 6,3 Hexagon*



mm				Art.-Nr.		EAN-Code	
2	25 mm	C 6,3	1/4"	10	<b>024 200 10</b>	5	40 07157 30952 5
2,5	25 mm	C 6,3	1/4"	10	<b>024 250 10</b>	5	40 07157 30253 3
3	25 mm	C 6,3	1/4"	10	<b>024 300 10</b>	5	40 07157 30255 7
4	25 mm	C 6,3	1/4"	10	<b>024 400 10</b>	5	40 07157 30257 1
5	25 mm	C 6,3	1/4"	10	<b>024 500 10</b>	6	40 07157 30259 5
5,5	25 mm	C 6,3	1/4"	10	<b>024 550 10</b>	6	40 07157 62319 5
6	25 mm	C 6,3	1/4"	10	<b>024 600 10</b>	7	40 07157 30261 8
8	25 mm	C 6,3	1/4"	10	<b>024 800 10</b>	9	40 07157 30263 2
3/32"	25 mm	C 6,3	1/4"	10	<b>024 238 10</b>	8	40 07157 64871 6
3/16"	25 mm	C 6,3	1/4"	10	<b>024 476 20</b>	8	40 07157 64873 0
1/4"	25 mm	C 6,3	1/4"	10	<b>024 635 20</b>	8	40 07157 64875 4

## 025 C 6,3



**Industrie Bit C 6,3 Square**  
*Industrial Bit C 6,3 Square*



SQ				Art.-Nr.		EAN-Code	
0 (1,75 mm)	25 mm	C 6,3	1/4"	10	<b>025 000 10</b>	4	40 07157 50350 3
1 (2,30 mm)	25 mm	C 6,3	1/4"	10	<b>025 100 10</b>	4	40 07157 50352 7
2 (2,80 mm)	25 mm	C 6,3	1/4"	10	<b>025 200 10</b>	5	40 07157 50354 1
3 (3,30 mm)	25 mm	C 6,3	1/4"	10	<b>025 300 10</b>	5	40 07157 50356 5

## 026 C 6,3



**Industrie Bit C 6,3 TORX®**  
*Industrial Bit C 6,3 TORX®*



Torx®				Art.-Nr.		EAN-Code	
5	25 mm	C 6,3	1/4"	10	<b>026 050 10</b>	4	40 07157 50779 2
6	25 mm	C 6,3	1/4"	10	<b>026 060 10</b>	4	40 07157 30953 2
7	25 mm	C 6,3	1/4"	10	<b>026 070 10</b>	4	40 07157 30954 9
8	25 mm	C 6,3	1/4"	10	<b>026 080 10</b>	4	40 07157 30955 6
9	25 mm	C 6,3	1/4"	10	<b>026 090 10</b>	4	40 07157 30956 3
10	25 mm	C 6,3	1/4"	10	<b>026 100 10</b>	5	40 07157 30957 0
10 (VE 100)	25 mm	C 6,3	1/4"	100	<b>026 100 17</b>	460	40 07157 31561 8
15	25 mm	C 6,3	1/4"	10	<b>026 150 10</b>	5	40 07157 30959 4
15 (VE 100)	25 mm	C 6,3	1/4"	100	<b>026 150 17</b>	480	40 07157 31563 2
20	25 mm	C 6,3	1/4"	10	<b>026 200 10</b>	5	40 07157 30961 7
20 (VE 100)	25 mm	C 6,3	1/4"	100	<b>026 200 17</b>	510	40 07157 31565 6
25	25 mm	C 6,3	1/4"	10	<b>026 250 10</b>	5	40 07157 30963 1
25 (VE 100)	25 mm	C 6,3	1/4"	100	<b>026 250 17</b>	530	40 07157 31567 0
27	25 mm	C 6,3	1/4"	10	<b>026 270 10</b>	5	40 07157 30965 5
30	25 mm	C 6,3	1/4"	10	<b>026 300 10</b>	6	40 07157 30967 9
30 (VE 100)	25 mm	C 6,3	1/4"	100	<b>026 300 17</b>	620	40 07157 31569 4
40	25 mm	C 6,3	1/4"	10	<b>026 400 10</b>	6	40 07157 30969 3
40 (VE 100)	25 mm	C 6,3	1/4"	100	<b>026 400 17</b>	620	40 07157 31571 7
45	25 mm	C 6,3	1/4"	10	<b>026 450 10</b>	7	40 07157 32076 6
50	26 mm	C 6,3	1/4"	10	<b>026 500 10</b>	8	40 07157 32450 4
50	32 mm	C 6,3	1/4"	10	<b>026 501 10</b>	10	40 07157 51399 1



# 027 C 6,3



## Industrie Bit C 6,3 TORX® TR

Industrial Bit C 6,3 TORX® TR



Torx® TR				Art.-Nr.		EAN-Code
<b>7 H</b>	25 mm	C 6,3 1/4"	10	<b>027 070 10</b>	4	40 07157 50771 6
<b>8 H</b>	25 mm	C 6,3 1/4"	10	<b>027 080 10</b>	4	40 07157 50773 0
<b>9 H</b>	25 mm	C 6,3 1/4"	10	<b>027 090 10</b>	4	40 07157 50775 4
<b>10 H</b>	25 mm	C 6,3 1/4"	10	<b>027 100 10</b>	5	40 07157 30971 6
<b>15 H</b>	25 mm	C 6,3 1/4"	10	<b>027 150 10</b>	5	40 07157 30972 3
<b>20 H</b>	25 mm	C 6,3 1/4"	10	<b>027 200 10</b>	5	40 07157 30973 0
<b>25 H</b>	25 mm	C 6,3 1/4"	10	<b>027 250 10</b>	5	40 07157 30974 7
<b>27 H</b>	25 mm	C 6,3 1/4"	10	<b>027 270 10</b>	5	40 07157 30975 4
<b>30 H</b>	25 mm	C 6,3 1/4"	10	<b>027 300 10</b>	6	40 07157 30976 1
<b>40 H</b>	25 mm	C 6,3 1/4"	10	<b>027 400 10</b>	6	40 07157 30977 8

# 023 C 6,3



## Industrie Bit C 6,3 TORX PLUS®

Industrial Bit C 6,3 TORX PLUS®



Torx Plus®				Art.-Nr.		EAN-Code
<b>6 IP</b>	25 mm	C 6,3 1/4"	10	<b>023 060 10</b>	4	40 07157 51341 0
<b>7 IP</b>	25 mm	C 6,3 1/4"	10	<b>023 070 10</b>	4	40 07157 51343 4
<b>8 IP</b>	25 mm	C 6,3 1/4"	10	<b>023 080 10</b>	4	40 07157 51345 8
<b>9 IP</b>	25 mm	C 6,3 1/4"	10	<b>023 090 10</b>	4	40 07157 51347 2
<b>10 IP</b>	25 mm	C 6,3 1/4"	10	<b>023 100 10</b>	5	40 07157 51349 6
<b>15 IP</b>	25 mm	C 6,3 1/4"	10	<b>023 150 10</b>	5	40 07157 51351 9
<b>20 IP</b>	25 mm	C 6,3 1/4"	10	<b>023 200 10</b>	5	40 07157 51353 3
<b>25 IP</b>	25 mm	C 6,3 1/4"	10	<b>023 250 10</b>	5	40 07157 51355 7
<b>27 IP</b>	25 mm	C 6,3 1/4"	10	<b>023 270 10</b>	6	40 07157 51357 1
<b>30 IP</b>	25 mm	C 6,3 1/4"	10	<b>023 300 10</b>	6	40 07157 51359 5
<b>40 IP</b>	25 mm	C 6,3 1/4"	10	<b>023 400 10</b>	6	40 07157 51361 8

# 028 C 6,3



## Industrie Bit C 6,3 Clutch

Industrial Bit C 6,3 Clutch



Clutch				Art.-Nr.		EAN-Code
<b>5/32"</b>	25 mm	C 6,3 1/4"	10	<b>028 930 10</b>	5	40 07157 52271 9
<b>1/4"</b>	25 mm	C 6,3 1/4"	10	<b>028 940 10</b>	6	40 07157 52273 3

## 028 C 6,3



### Industrie Bit C 6,3 XZN

Industrial Bit C 6,3 XZN



XZN				Art.-Nr.		EAN-Code
<b>M 4</b>	25 mm	C 6,3	1/4"	10	<b>028 040 10</b>	5 40 07157 50360 2
<b>M 5</b>	25 mm	C 6,3	1/4"	10	<b>028 050 10</b>	5 40 07157 50362 6
<b>M 6</b>	25 mm	C 6,3	1/4"	10	<b>028 060 10</b>	6 40 07157 50364 0
<b>M 8</b>	25 mm	C 6,3	1/4"	10	<b>028 080 10</b>	6 40 07157 50366 4
<b>M10</b>	25 mm	C 6,3	1/4"	10	<b>028 100 10</b>	8 40 07157 50368 8

## 029 C 6,3



### Industrie Bit C 6,3 Torq-Set

Industrial Bit C 6,3 Torq-Set



TS				Art.-Nr.		EAN-Code
<b>0</b>	25 mm	C 6,3	1/4"	10	<b>029 000 10</b>	5 40 07157 50370 1
<b>1</b>	25 mm	C 6,3	1/4"	10	<b>029 010 10</b>	6 40 07157 50372 5
<b>2</b>	25 mm	C 6,3	1/4"	10	<b>029 020 10</b>	5 40 07157 50374 9
<b>3</b>	25 mm	C 6,3	1/4"	10	<b>029 030 10</b>	5 40 07157 50376 3
<b>4</b>	25 mm	C 6,3	1/4"	10	<b>029 040 10</b>	5 40 07157 50378 7
<b>5</b>	25 mm	C 6,3	1/4"	10	<b>029 050 10</b>	5 40 07157 50380 0
<b>6</b>	25 mm	C 6,3	1/4"	10	<b>029 060 10</b>	5 40 07157 50382 4
<b>8</b>	25 mm	C 6,3	1/4"	10	<b>029 080 10</b>	6 40 07157 50536 1
<b>10</b>	25 mm	C 6,3	1/4"	10	<b>029 100 10</b>	6 40 07157 50819 5

## 029 C 6,3



### Industrie Bit C 6,3 Tri-Wing

Industrial Bit C 6,3 Tri-Wing



Tri-Wing				Art.-Nr.		EAN-Code
<b>1</b>	25 mm	C 6,3	1/4"	10	<b>029 510 10</b>	5 40 07157 52255 9
<b>2</b>	25 mm	C 6,3	1/4"	10	<b>029 520 10</b>	5 40 07157 52257 3
<b>3</b>	25 mm	C 6,3	1/4"	10	<b>029 530 10</b>	5 40 07157 52259 7
<b>4</b>	25 mm	C 6,3	1/4"	10	<b>029 540 10</b>	5 40 07157 52261 0
<b>5</b>	25 mm	C 6,3	1/4"	10	<b>029 550 10</b>	5 40 07157 52263 4

## 020 C 6,3



### Industrie Bit C 6,3 Spanner

Industrial Bit C 6,3 Spanner



Spanner				Art.-Nr.		EAN-Code
<b>6</b>	25 mm	C 6,3	1/4"	10	<b>020 906 10</b>	5 40 07157 52265 8
<b>8</b>	25 mm	C 6,3	1/4"	10	<b>020 908 10</b>	5 40 07157 52267 2
<b>10</b>	25 mm	C 6,3	1/4"	10	<b>020 910 10</b>	5 40 07157 52269 6

# 030 E 6,3

**Industrie Bit E 6,3 Schlitz**  
*Industrial Bit E 6,3 Slotted*



				Art.-Nr.		EAN-Code
<b>3,0 x 0,5</b>	50 mm	E 6,3 1/4"	10	<b>030 305 10</b>	8	40 07157 30772 9
<b>3,5 x 0,6</b>	50 mm	E 6,3 1/4"	10	<b>030 315 10</b>	8	40 07157 30275 5
<b>4,0 x 0,8</b>	50 mm	E 6,3 1/4"	10	<b>030 415 10</b>	9	40 07157 30277 9
<b>5,5 x 1,0</b>	50 mm	E 6,3 1/4"	10	<b>030 525 10</b>	10	40 07157 30285 4
<b>6,5 x 1,2</b>	50 mm	E 6,3 1/4"	10	<b>030 615 10</b>	12	40 07157 30290 8
<b>8,0 x 1,6</b>	50 mm	E 6,3 1/4"	10	<b>030 815 10</b>	14	40 07157 30294 6
<b>10,0 x 1,6</b>	50 mm	E 6,3 1/4"	10	<b>030 105 10</b>	17	40 07157 30272 4

# 031 E 6,3

**Industrie Bit E 6,3 Pozidriv**  
*Industrial Bit E 6,3 Pozidriv*



				Art.-Nr.		EAN-Code
<b>1</b>	50 mm	E 6,3 1/4"	10	<b>031 015 10</b>	9	40 07157 30309 7
<b>2</b>	50 mm	E 6,3 1/4"	10	<b>031 025 10</b>	11	40 07157 30312 7
<b>3</b>	50 mm	E 6,3 1/4"	10	<b>031 035 10</b>	11	40 07157 30315 8

# 032 E 6,3

**Industrie Bit E 6,3 Phillips**  
*Industrial Bit E 6,3 Phillips*



				Art.-Nr.		EAN-Code
<b>0</b>	50 mm	E 6,3 1/4"	10	<b>032 005 10</b>	8	40 07157 51015 0
<b>1</b>	50 mm	E 6,3 1/4"	10	<b>032 015 10</b>	9	40 07157 30317 2
<b>2</b>	50 mm	E 6,3 1/4"	10	<b>032 025 10</b>	11	40 07157 30320 2
<b>2 (VE 100)</b>	50 mm	E 6,3 1/4"	100	<b>032 025 17</b>	1100	40 07157 31956 2
<b>3</b>	50 mm	E 6,3 1/4"	10	<b>032 035 10</b>	12	40 07157 30323 3

# 033 E 6,3

**Industrie Bit E 6,3 TORX PLUS®**  
*Industrial Bit E 6,3 TORX PLUS®*



				Art.-Nr.		EAN-Code
<b>10 IP</b>	50 mm	E 6,3 1/4"	10	<b>033 105 10</b>	8	40 07157 51363 2
<b>15 IP</b>	50 mm	E 6,3 1/4"	10	<b>033 155 10</b>	9	40 07157 51365 6
<b>20 IP</b>	50 mm	E 6,3 1/4"	10	<b>033 205 10</b>	9	40 07157 51367 0
<b>25 IP</b>	50 mm	E 6,3 1/4"	10	<b>033 255 10</b>	10	40 07157 51369 4
<b>30 IP</b>	50 mm	E 6,3 1/4"	10	<b>033 305 10</b>	11	40 07157 51371 7

## 034 E 6,3



**Industrie Bit E 6,3 Sechskant**  
*Industrial Bit E 6,3 Hexagon*



mm				Art.-Nr.		EAN-Code
2,5	50 mm	E 6,3 1/4"	10	<b>034 255 10</b>	11	40 07157 30325 7
3,0	50 mm	E 6,3 1/4"	10	<b>034 305 10</b>	11	40 07157 30327 1
4,0	50 mm	E 6,3 1/4"	10	<b>034 405 10</b>	12	40 07157 30329 5
5,0	50 mm	E 6,3 1/4"	10	<b>034 505 10</b>	12	40 07157 30331 8
6,0	50 mm	E 6,3 1/4"	10	<b>034 605 10</b>	13	40 07157 30333 2
8,0	50 mm	E 6,3 1/4"	10	<b>034 805 10</b>	17	40 07157 31878 7

## 035 E 6,3



**Industrie Bit E 6,3 Square**  
*Industrial Bit E 6,3 Square*



SQ				Art.-Nr.		EAN-Code
1 (2,30 mm)	50 mm	E 6,3 1/4"	10	<b>035 105 10</b>	11	40 07157 63601 0
2 (2,80 mm)	50 mm	E 6,3 1/4"	10	<b>035 205 10</b>	11	40 07157 63603 4
3 (3,30 mm)	50 mm	E 6,3 1/4"	10	<b>035 305 10</b>	12	40 07157 63605 8

## 036 E 6,3



**Industrie Bit E 6,3 TORX®**  
*Industrial Bit E 6,3 TORX®*



Torx®				Art.-Nr.		EAN-Code
5	50 mm	E 6,3 1/4"	10	<b>036 055 10</b>	7	40 07157 50973 4
6	50 mm	E 6,3 1/4"	10	<b>036 065 10</b>	7	40 07157 51375 5
7	50 mm	E 6,3 1/4"	10	<b>036 075 10</b>	7	40 07157 51377 9
8	50 mm	E 6,3 1/4"	10	<b>036 085 10</b>	8	40 07157 30834 4
9	50 mm	E 6,3 1/4"	10	<b>036 095 10</b>	8	40 07157 30835 1
10	50 mm	E 6,3 1/4"	10	<b>036 105 10</b>	9	40 07157 30836 8
15	50 mm	E 6,3 1/4"	10	<b>036 155 10</b>	8	40 07157 24026 2
20	50 mm	E 6,3 1/4"	10	<b>036 205 10</b>	9	40 07157 30839 9
25	50 mm	E 6,3 1/4"	10	<b>036 255 10</b>	9	40 07157 30841 2
27	50 mm	E 6,3 1/4"	10	<b>036 275 10</b>	9	40 07157 30843 6
30	50 mm	E 6,3 1/4"	10	<b>036 305 10</b>	11	40 07157 30845 0
40	50 mm	E 6,3 1/4"	10	<b>036 405 10</b>	12	40 07157 30847 4

## 030 E 6,3



**Industrie Bit E 6,3 Schlitz**  
*Industrial Bit E 6,3 Slotted*



						Art.-Nr.		EAN-Code
<b>3,0 x 0,5</b>	73 mm	E 6,3	1/4"	5		<b>030 307 10</b>	9	40 07157 30274 8
<b>3,5 x 0,6</b>	73 mm	E 6,3	1/4"	5		<b>030 317 10</b>	11	40 07157 30773 6
<b>4,0 x 0,8</b>	73 mm	E 6,3	1/4"	5		<b>030 417 10</b>	11	40 07157 30279 3
<b>5,5 x 1,0</b>	73 mm	E 6,3	1/4"	5		<b>030 527 10</b>	14	40 07157 30787 3
<b>6,5 x 1,2</b>	73 mm	E 6,3	1/4"	5		<b>030 617 10</b>	17	40 07157 30794 1

## 031 E 6,3



**Industrie Bit E 6,3 Pozidriv**  
*Industrial Bit E 6,3 Pozidriv*



PZ					Art.-Nr.		EAN-Code
<b>1</b>	73 mm	E 6,3	1/4"	5	<b>031 017 10</b>	12	40 07157 30311 0
<b>2</b>	73 mm	E 6,3	1/4"	5	<b>031 027 10</b>	16	40 07157 30314 1
<b>3</b>	73 mm	E 6,3	1/4"	5	<b>031 037 10</b>	18	40 07157 30815 3

## 032 E 6,3



**Industrie Bit E 6,3 Phillips**  
*Industrial Bit E 6,3 Phillips*



PH					Art.-Nr.		EAN-Code
<b>1</b>	73 mm	E 6,3	1/4"	5	<b>032 017 10</b>	12	40 07157 30319 6
<b>2</b>	73 mm	E 6,3	1/4"	5	<b>032 027 10</b>	16	40 07157 30322 6
<b>3</b>	73 mm	E 6,3	1/4"	5	<b>032 037 10</b>	18	40 07157 30833 7

## 035 E 6,3



**Industrie Bit E 6,3 Square**  
*Industrial Bit E 6,3 Square*



SQ					Art.-Nr.		EAN-Code
<b>0</b> (1,75 mm)	73 mm	E 6,3	1/4"	5	<b>035 007 10</b>	17	40 07157 31520 5
<b>1</b> (2,30 mm)	73 mm	E 6,3	1/4"	5	<b>035 017 10</b>	17	40 07157 31522 9
<b>2</b> (2,80 mm)	73 mm	E 6,3	1/4"	5	<b>035 027 10</b>	18	40 07157 31524 3
<b>3</b> (3,30 mm)	73 mm	E 6,3	1/4"	5	<b>035 037 10</b>	18	40 07157 31526 7

## 036 E 6,3



**Industrie Bit E 6,3 TORX®**  
*Industrial Bit E 6,3 TORX®*



Torx®					Art.-Nr.		EAN-Code
<b>10</b>	73 mm	E 6,3	1/4"	3	<b>036 107 10</b>	10	40 07157 30837 5
<b>15</b>	73 mm	E 6,3	1/4"	3	<b>036 157 10</b>	11	40 07157 30838 2
<b>20</b>	73 mm	E 6,3	1/4"	3	<b>036 207 10</b>	12	40 07157 30840 5
<b>25</b>	73 mm	E 6,3	1/4"	3	<b>036 257 10</b>	13	40 07157 30842 9
<b>27</b>	73 mm	E 6,3	1/4"	3	<b>036 277 10</b>	14	40 07157 30844 3
<b>30</b>	73 mm	E 6,3	1/4"	3	<b>036 307 10</b>	17	40 07157 30846 7
<b>40</b>	73 mm	E 6,3	1/4"	3	<b>036 407 10</b>	19	40 07157 30848 1



## 031 E 6,3



**Industrie Bit E 6,3 (+/-) Z**  
*Industrial Bit E 6,3 (+/-) Z*

For terminal block screws



PlusMinus				Art.-Nr.		EAN-Code
Z 1	73 mm	E 6,3	1/4"	5	<b>031 101 10</b>	12 40 07157 51883 5
Z 2	73 mm	E 6,3	1/4"	5	<b>031 202 10</b>	16 40 07157 51885 9

## 032 E 6,3



**Industrie Bit E 6,3 (+/-) H**  
*Industrial Bit E 6,3 (+/-) H*

For terminal block screws



Plus				Art.-Nr.		EAN-Code
H 1	73 mm	E 6,3	1/4"	5	<b>032 101 10</b>	12 40 07157 51879 8
H 2	73 mm	E 6,3	1/4"	5	<b>032 202 10</b>	16 40 07157 51881 1

## 036 E 6,3



**Industrie Bit E 6,3 TORX®**  
*Industrial Bit E 6,3 TORX®*



Torx®				Art.-Nr.		EAN-Code
T 10	100 mm	E 6,3	1/4"	3	<b>036 109 10</b>	14 40 07157 64907 2
T 15	100 mm	E 6,3	1/4"	3	<b>036 159 10</b>	15 40 07157 64909 6
T 20	100 mm	E 6,3	1/4"	3	<b>036 209 10</b>	17 40 07157 51255 0
T 25	100 mm	E 6,3	1/4"	3	<b>036 259 10</b>	18 40 07157 51253 6
T 30	100 mm	E 6,3	1/4"	3	<b>036 309 10</b>	23 40 07157 51407 3
T 40	100 mm	E 6,3	1/4"	3	<b>036 409 10</b>	25 40 07157 51409 7

## 030 E 6,3



**Industrie Bit E 6,3 Schlitz**  
*Industrial Bit E 6,3 Slotted*



				Art.-Nr.		EAN-Code
4,0 x 0,8	100 mm	E 6,3	1/4"	3	<b>030 418 10</b>	14 40 07157 30778 1
5,5 x 1,0	100 mm	E 6,3	1/4"	3	<b>030 528 10</b>	19 40 07157 30788 0
6,5 x 1,2	100 mm	E 6,3	1/4"	3	<b>030 618 10</b>	24 40 07157 30795 8
8,0 x 1,2	100 mm	E 6,3	1/4"	3	<b>030 818 10</b>	33 40 07157 30800 9

## 031 E 6,3



**Industrie Bit E 6,3 Pozidriv**  
*Industrial Bit E 6,3 Pozidriv*



PZ				Art.-Nr.		EAN-Code
1	100 mm	E 6,3	1/4"	3	<b>031 018 10</b>	15 40 07157 30805 4
2	100 mm	E 6,3	1/4"	3	<b>031 028 10</b>	22 40 07157 30810 8
3	100 mm	E 6,3	1/4"	3	<b>031 038 10</b>	25 40 07157 30816 0

## 032 E 6,3



**Industrie Bit E 6,3 Phillips**  
*Industrial Bit E 6,3 Phillips*



PH				Art.-Nr.		EAN-Code
1	100 mm	E 6,3	1/4"	3	<b>032 018 10</b>	15 40 07157 30822 1
2	100 mm	E 6,3	1/4"	3	<b>032 028 10</b>	22 40 07157 30828 3



# 031 E 6,3

## Industrie Bit E 6,3 Pozidriv

Industrial Bit E 6,3 Pozidriv



PZ					Art.-Nr.		EAN-Code
1	150 mm	E 6,3	1/4"	3	<b>031 019 10</b>	22	40 07157 30752 1
2	150 mm	E 6,3	1/4"	3	<b>031 029 10</b>	33	40 07157 30812 2
3	150 mm	E 6,3	1/4"	3	<b>031 039 10</b>	39	40 07157 30817 7



# 032 E 6,3

## Industrie Bit E 6,3 Phillips

Industrial Bit E 6,3 Phillips



PH					Art.-Nr.		EAN-Code
1	150 mm	E 6,3	1/4"	3	<b>032 019 10</b>	22	40 07157 30823 8
2	150 mm	E 6,3	1/4"	3	<b>032 029 10</b>	33	40 07157 30830 6



# 036 E 6,3

## Industrie Bit E 6,3 TORX®

Industrial Bit E 6,3 TORX®



Torx®					Art.-Nr.		EAN-Code
10	150 mm	E 6,3	1/4"	3	<b>036 100 10</b>	22	40 07157 63839 7
15	150 mm	E 6,3	1/4"	3	<b>036 150 10</b>	22	40 07157 63565 5
20	150 mm	E 6,3	1/4"	3	<b>036 200 10</b>	33	40 07157 63567 9
25	150 mm	E 6,3	1/4"	3	<b>036 250 10</b>	39	40 07157 63569 3
30	150 mm	E 6,3	1/4"	3	<b>036 300 10</b>	42	40 07157 63571 6

## IMPACT Bits

### 021 C 6,3



#### IMPACT Bit C 6,3 Pozidriv

IMPACT Bit C 6,3 Pozidriv



IMPACT PZ				Art.-Nr.		EAN-Code
1	25 mm	C 6,3 1/4"	5	<b>021 010 40</b>	3	40 07157 62939 5
2	25 mm	C 6,3 1/4"	5	<b>021 020 40</b>	4	40 07157 62941 8
3	25 mm	C 6,3 1/4"	5	<b>021 030 40</b>	5	40 07157 62943 2

### 022 C 6,3



#### IMPACT Bit C 6,3 Phillips

IMPACT Bit C 6,3 Phillips



IMPACT PH				Art.-Nr.		EAN-Code
1	25 mm	C 6,3 1/4"	5	<b>022 010 40</b>	3	40 07157 62933 3
2	25 mm	C 6,3 1/4"	5	<b>022 020 40</b>	4	40 07157 62935 7
3	25 mm	C 6,3 1/4"	5	<b>022 030 40</b>	5	40 07157 62937 1

### 024 C 6,3



#### IMPACT Bit C 6,3 HEX

IMPACT Bit C 6,3 HEX



IMPACT HEX				Art.-Nr.		EAN-Code
3,0 mm	25 mm	C 6,3 1/4"	5	<b>024 300 40</b>	5	40 07157 64877 8
4,0 mm	25 mm	C 6,3 1/4"	5	<b>024 400 40</b>	5	40 07157 64879 2
5,0 mm	25 mm	C 6,3 1/4"	5	<b>024 500 40</b>	6	40 07157 64881 5
6,0 mm	25 mm	C 6,3 1/4"	5	<b>024 600 40</b>	7	40 07157 64883 9

### 025 C 6,3



#### IMPACT Bit C 6,3 Square

IMPACT Bit C 6,3 Square



IMPACT SQ				Art.-Nr.		EAN-Code
SQ 1	25 mm	C 6,3 1/4"	5	<b>025 100 40</b>	4	40 07157 64885 3
SQ 2	25 mm	C 6,3 1/4"	5	<b>025 200 40</b>	5	40 07157 64887 7
SQ 3	25 mm	C 6,3 1/4"	5	<b>025 300 40</b>	5	40 07157 64889 1

### 026 C 6,3



#### IMPACT Bit C 6,3 TORX®

IMPACT Bit C 6,3 TORX®



IMPACT Torx®				Art.-Nr.		EAN-Code
10	25 mm	C 6,3 1/4"	5	<b>026 100 40</b>	3	40 07157 62945 6
15	25 mm	C 6,3 1/4"	5	<b>026 150 40</b>	3	40 07157 62947 0
20	25 mm	C 6,3 1/4"	5	<b>026 200 40</b>	4	40 07157 62949 4
25	25 mm	C 6,3 1/4"	5	<b>026 250 40</b>	4	40 07157 62951 7
27	25 mm	C 6,3 1/4"	5	<b>026 270 40</b>	5	40 07157 64891 4
30	25 mm	C 6,3 1/4"	5	<b>026 300 40</b>	5	40 07157 62953 1
40	25 mm	C 6,3 1/4"	5	<b>026 400 40</b>	5	40 07157 62955 5

# 031 E 6,3



**IMPACT Bit E 6,3 Pozidriv**  
*IMPACT Bit E 6,3 Pozidriv*



IMPACT PZ				Art.-Nr.		EAN-Code
<b>1</b>	50 mm	E 6,3 1/4"	5	<b>031 015 40</b>	6	40 07157 62963 0
<b>2</b>	50 mm	E 6,3 1/4"	5	<b>031 025 40</b>	7	40 07157 62965 4
<b>3</b>	50 mm	E 6,3 1/4"	5	<b>031 035 40</b>	8	40 07157 62967 8

# 032 E 6,3



**IMPACT Bit E 6,3 Phillips**  
*IMPACT Bit E 6,3 Phillips*



IMPACT PH				Art.-Nr.		EAN-Code
<b>1</b>	50 mm	E 6,3 1/4"	5	<b>032 015 40</b>	6	40 07157 62957 9
<b>2</b>	50 mm	E 6,3 1/4"	5	<b>032 025 40</b>	7	40 07157 62959 3
<b>3</b>	50 mm	E 6,3 1/4"	5	<b>032 035 40</b>	8	40 07157 62961 6

# 034 E 6,3



**IMPACT Bit E 6,3 HEX**  
*IMPACT Bit E 6,3 HEX*



IMPACT HEX				Art.-Nr.		EAN-Code
<b>3,0 mm</b>	50 mm	E 6,3 1/4"	5	<b>034 305 40</b>	8	40 07157 64893 8
<b>4,0 mm</b>	50 mm	E 6,3 1/4"	5	<b>034 405 40</b>	8	40 07157 64895 2
<b>5,0 mm</b>	50 mm	E 6,3 1/4"	5	<b>034 505 40</b>	9	40 07157 64897 6
<b>6,0 mm</b>	50 mm	E 6,3 1/4"	5	<b>034 605 40</b>	10	40 07157 64899 0

# 035 E 6,3



**IMPACT Bit E 6,3 Square**  
*IMPACT Bit E 6,3 Square*



IMPACT SQ				Art.-Nr.		EAN-Code
<b>SQ 1</b>	50 mm	E 6,3 1/4"	5	<b>035 105 40</b>	8	40 07157 64901 0
<b>SQ 2</b>	50 mm	E 6,3 1/4"	5	<b>035 205 40</b>	8	40 07157 64903 4
<b>SQ 3</b>	50 mm	E 6,3 1/4"	5	<b>035 305 40</b>	8	40 07157 64905 8

# 036 E 6,3



**IMPACT Bit E 6,3 TORX®**  
*IMPACT Bit E 6,3 TORX®*



IMPACT Torx®				Art.-Nr.		EAN-Code
<b>10</b>	50 mm	E 6,3 1/4"	5	<b>036 105 40</b>	8	40 07157 62969 2
<b>15</b>	50 mm	E 6,3 1/4"	5	<b>036 155 40</b>	8	40 07157 62971 5
<b>20</b>	50 mm	E 6,3 1/4"	5	<b>036 205 40</b>	8	40 07157 62973 9
<b>25</b>	50 mm	E 6,3 1/4"	5	<b>036 255 40</b>	8	40 07157 62975 3
<b>27</b>	50 mm	E 6,3 1/4"	5	<b>036 275 40</b>	8	40 07157 64911 9
<b>30</b>	50 mm	E 6,3 1/4"	5	<b>036 305 40</b>	9	40 07157 62977 7
<b>40</b>	50 mm	E 6,3 1/4"	5	<b>036 405 40</b>	9	40 07157 62979 1

## Diamant Bits

### Diamond Bits



**Diamond coated**



## 021 C 6,3



### Diamant Bit C 6,3 Pozidriv

*Diamond Bit C 6,3 Pozidriv*



PZ					Art.-Nr.		EAN-Code
<b>1</b>	25 mm	C 6,3	1/4"	10	<b>021 010 80</b>	4	40 07157 50661 0
<b>2</b>	25 mm	C 6,3	1/4"	10	<b>021 020 80</b>	5	40 07157 50663 4
<b>3</b>	25 mm	C 6,3	1/4"	10	<b>021 030 80</b>	5	40 07157 50665 8

## 022 C 6,3



### Diamant Bit C 6,3 Phillips

*Diamond Bit C 6,3 Phillips*



PH					Art.-Nr.		EAN-Code
<b>1</b>	25 mm	C 6,3	1/4"	10	<b>022 010 80</b>	4	40 07157 50655 9
<b>2</b>	25 mm	C 6,3	1/4"	10	<b>022 020 80</b>	5	40 07157 50657 3
<b>3</b>	25 mm	C 6,3	1/4"	10	<b>022 030 80</b>	5	40 07157 50659 7





## TiN Bits

TiN (>90 HRC)

SX 75 (>60 HRC)



**021**  
**C 6,3**  
**TiN**

**TiN Bit C 6,3 Pozidriv**

*TiN Bit C 6,3 Pozidriv*



PZ				Art.-Nr.		EAN-Code	
<b>1</b>	25 mm	C 6,3	1/4"	10	<b>021 010 70</b>	5	40 07157 10313 0
<b>1 (VE 100)</b>	25 mm	C 6,3	1/4"	100	<b>021 010 77</b>	500	40 07157 53415 6
<b>2</b>	25 mm	C 6,3	1/4"	10	<b>021 020 70</b>	5	40 07157 10314 7
<b>2 (VE 100)</b>	25 mm	C 6,3	1/4"	100	<b>021 020 76</b>	500	40 07157 53417 0
<b>3</b>	25 mm	C 6,3	1/4"	10	<b>021 030 70</b>	5	40 07157 10315 4
<b>3 (VE 100)</b>	25 mm	C 6,3	1/4"	100	<b>021 030 77</b>	500	40 07157 53419 4

**022**  
**C 6,3**  
**TiN**

**TiN Bit C 6,3 Phillips**

*TiN Bit C 6,3 Phillips*



PH				Art.-Nr.		EAN-Code	
<b>1</b>	25 mm	C 6,3	1/4"	10	<b>022 010 70</b>	5	40 07157 10316 1
<b>1 (VE 100)</b>	25 mm	C 6,3	1/4"	100	<b>022 010 77</b>	500	40 07157 53421 7
<b>2</b>	25 mm	C 6,3	1/4"	10	<b>022 020 70</b>	5	40 07157 10317 8
<b>2 (VE 100)</b>	25 mm	C 6,3	1/4"	100	<b>022 020 77</b>	500	40 07157 52339 6
<b>3</b>	25 mm	C 6,3	1/4"	10	<b>022 030 70</b>	5	40 07157 10318 5
<b>3 (VE 100)</b>	25 mm	C 6,3	1/4"	100	<b>022 030 77</b>	500	40 07157 53423 1

**022**  
**C 6,3**  
**TiN**

**TiN Bit C 6,3 Phillips „Grabber“**

*TiN Bit C 6,3 Phillips "Grabber"*



**extra slim**



PH				Art.-Nr.		EAN-Code	
<b>2</b>	25 mm	C 6,3	1/4"	10	<b>022 002 70</b>	5	40 07157 52471 3

# 026 C 6,3 TiN



## TiN Bit C 6,3 TORX®

TiN Bit C 6,3 TORX®



Torx®				Art.-Nr.		EAN-Code
<b>10</b>	25 mm	C 6,3	1/4"	10	<b>026 100 70</b>	5 40 07157 50220 9
<b>15</b>	25 mm	C 6,3	1/4"	10	<b>026 150 70</b>	5 40 07157 50222 3
<b>15 (VE 100)</b>	25 mm	C 6,3	1/4"	100	<b>026 150 77</b>	500 40 07157 52321 1
<b>20</b>	25 mm	C 6,3	1/4"	10	<b>026 200 70</b>	5 40 07157 50224 7
<b>20 (VE 100)</b>	25 mm	C 6,3	1/4"	100	<b>026 200 77</b>	500 40 07157 52323 5
<b>25</b>	25 mm	C 6,3	1/4"	10	<b>026 250 70</b>	5 40 07157 50226 1
<b>25 (VE 100)</b>	25 mm	C 6,3	1/4"	100	<b>026 250 77</b>	500 40 07157 52325 9
<b>27</b>	25 mm	C 6,3	1/4"	10	<b>026 270 70</b>	5 40 07157 50228 5
<b>30</b>	25 mm	C 6,3	1/4"	10	<b>026 300 70</b>	6 40 07157 50230 8
<b>40</b>	25 mm	C 6,3	1/4"	10	<b>026 400 70</b>	6 40 07157 50232 2
<b>45</b>	25 mm	C 6,3	1/4"	10	<b>026 450 70</b>	7 40 07157 50234 6

# 031 E 6,3 TiN



## TiN Bit E 6,3 Pozidriv

TiN Bit E 6,3 Pozidriv



PZ				Art.-Nr.		EAN-Code
<b>1</b>	50 mm	E 6,3	1/4"	10	<b>031 015 70</b>	9 40 07157 30801 6
<b>2</b>	50 mm	E 6,3	1/4"	10	<b>031 025 70</b>	11 40 07157 30806 1
<b>3</b>	50 mm	E 6,3	1/4"	10	<b>031 035 70</b>	12 40 07157 30813 9

# 032 E 6,3 TiN



## TiN Bit E 6,3 Phillips

TiN Bit E 6,3 Phillips



PH				Art.-Nr.		EAN-Code
<b>1</b>	50 mm	E 6,3	1/4"	10	<b>032 015 70</b>	9 40 07157 30818 4
<b>2</b>	50 mm	E 6,3	1/4"	10	<b>032 025 70</b>	11 40 07157 30824 5
<b>3</b>	50 mm	E 6,3	1/4"	10	<b>032 035 70</b>	12 40 07157 30831 3



## Spezialbits & Adapter Special Bits and Adapters

### 029 C 6,3

Industrie Bit C 6,3 LocTec®  
Industrial Bit C 6,3 LocTec®



LocTec®				Art.-Nr.		EAN-Code
15- LID	25	C 6,3 1/4"	10	<b>029 300 10</b>	5	40 07157 60379 1
20- LID	25	C 6,3 1/4"	10	<b>029 400 10</b>	5	40 07157 60381 4
25- LID	25	C 6,3 1/4"	10	<b>029 500 10</b>	6	40 07157 60383 8
30- LID	25	C 6,3 1/4"	10	<b>029 600 10</b>	6	40 07157 60385 2

### 079 C 8

Industrie Bit C 6,3 LocTec®  
Industrial Bit C 6,3 LocTec®



LocTec®				Art.-Nr.		EAN-Code
45- LID	30	C 8 5/16"	10	<b>079 080 10</b>	11	40 07157 60389 0
50- LID	30	C 8 5/16"	10	<b>079 100 10</b>	11	40 07157 60387 6

### Einschrauben

*Screw in*

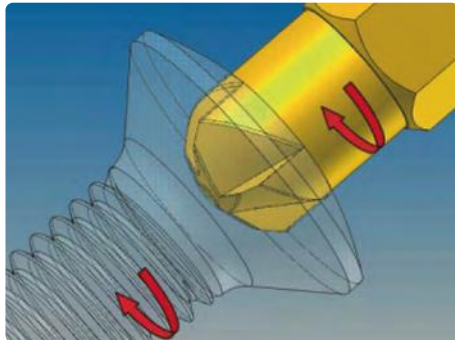

Die LocTec® Schraube wird einfach mit dem Sicherungsbit verschraubt. Weitere Sicherungsmaßnahmen sind nicht mehr notwendig.

*Simply screw in the LocTec® screw with the locking bit. No other locking measures are required.*

### Löseversuch

*Attempt to loosen the screw*

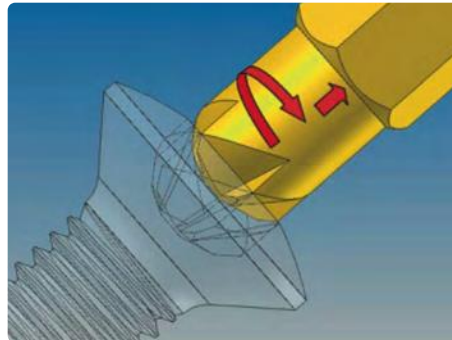

Die spezielle Flankenengeometrie sorgt dafür, dass jeglicher Lösungsversuch, auch unter Verwendung des Sicherungsbits, mit dem Herausdrehen des Montagewerkzeuges endet.

*The special flank geometry ensures that any attempt to loosen the screw – even with the locking bit – will fail, since it will merely drive the fitting tool out.*

**Mehr Information unter: /**

*For more information visit  
[www.arnold-umformtechnik.de](http://www.arnold-umformtechnik.de)*

## 039 E 6,3

### Steckschlüsselbit E 6,3 metrisch mit Magnet

Socket Bit E 6,3 metric  
with magnet



mm				Art.-Nr.		EAN-Code
5	66 mm	E 6,3	1/4"	5	<b>039 050 10</b>	28 40 07157 50404 3
6	66 mm	E 6,3	1/4"	5	<b>039 060 10</b>	27 40 07157 50406 7
7	66 mm	E 6,3	1/4"	5	<b>039 070 10</b>	26 40 07157 51373 1
8	66 mm	E 6,3	1/4"	5	<b>039 080 10</b>	31 40 07157 50408 1
9	66 mm	E 6,3	1/4"	5	<b>039 090 10</b>	33 40 07157 53245 9
10	66 mm	E 6,3	1/4"	5	<b>039 100 10</b>	36 40 07157 50410 4
11	66 mm	E 6,3	1/4"	5	<b>039 110 10</b>	36 40 07157 53247 3
12	66 mm	E 6,3	1/4"	5	<b>039 120 10</b>	39 40 07157 53249 7
13	66 mm	E 6,3	1/4"	5	<b>039 130 10</b>	54 40 07157 50412 8

## 039 E 6,3

### Steckschlüsselbit E 6,3 Inch mit Magnet

Socket Bit E 6,3 Inch  
with magnet



				Art.-Nr.		EAN-Code
5/16"	66 mm	E 6,3	1/4"	5	<b>039 516 10</b>	31 40 07157 50414 2
3/8"	66 mm	E 6,3	1/4"	5	<b>039 038 10</b>	36 40 07157 50416 6

## 039 E 6,3

### Steckschlüsselbitsatz E 6,3 metrisch mit Magnet

Socket Bitset E 6,3 metric  
with magnet



			Art.-Nr.		EAN-Code
6 / 7 / 8 / 10 / 12 / 13 mm			<b>039 961 06</b>	550	40 07157 63841

## Spezial Bits für direkten Maschinenanschluss

Special Bits for direct fit

 <b>A5,5</b> AEG BOSC HOLZ-HER KRESS METABO	 <b>G7</b> BAIER FEIN	 <b>C8</b> BOSCH FEIN HOLZ-HER LECUREUX METABO	 <b>M5</b> BÖLLHOFF/ UNIGUIC HOLZ-HER WEBER	 <b>10/32" NFA</b> USM DUOFAST DVSG
---------------------------------------------------------------	--------------------------------	------------------------------------------------------------------	------------------------------------------------------------	-------------------------------------------------



## 011 A 5,5



**Industrie Bit A 5,5 Pozidriv**  
*Industrial Bit A 5,5 Pozidriv*



PZ	↔		⬠	📦	Art.-Nr.	📦	EAN-Code
2	50 mm	A 5,5	5,5 mm	10	<b>011 025 10</b>	10	40 07157 30021 8
3	50 mm	A 5,5	5,5 mm	10	<b>011 035 10</b>	12	40 07157 30023 2

## 012 A 5,5



**Industrie Bit A 5,5 Phillips**  
*Industrial Bit A 5,5 Phillips*



PH	↔		⬠	📦	Art.-Nr.	📦	EAN-Code
2	50 mm	A 5,5	5,5 mm	10	<b>012 025 10</b>	10	40 07157 30027 0
3	50 mm	A 5,5	5,5 mm	10	<b>012 035 10</b>	13	40 07157 30029 4

## 014 A 5,5



**Industrie Bit A 5,5 Sechskant**  
*Industrial Bit A 5,5 Hexagon*



mm	↔		⬠	📦	Art.-Nr.	📦	EAN-Code
<b>2,5</b>	50 mm	A 5,5	5,5 mm	10	<b>014 255 10</b>	7	40 07157 30031 7
<b>3,0</b>	50 mm	A 5,5	5,5 mm	10	<b>014 305 10</b>	8	40 07157 30033 1
<b>4,0</b>	50 mm	A 5,5	5,5 mm	10	<b>014 405 10</b>	9	40 07157 30035 5
<b>5,0</b>	50 mm	A 5,5	5,5 mm	10	<b>014 505 10</b>	11	40 07157 30037 9
<b>6,0</b>	50 mm	A 5,5	5,5 mm	10	<b>014 605 10</b>	12	40 07157 30039 3

**»felo ist Ihr erfahrener Spezialist für Sonderanfertigungen und Problemlösungen in höchster Qualität.**

*»felo is your specialist with great experience in custom made items and solutions of the highest quality.*



## 061 6,3 mm



**Industrie Umsteckbit 1/4" Pozidriv**  
*Industrial Reversible Bit 1/4" Pozidriv*



PZ	—	⬮	⊞	Art.-Nr.	📦	EAN-Code
1/2	60 mm	1/4"	10	<b>061 126 10</b>	13	40 07157 30429 2
2/2	60 mm	1/4"	10	<b>061 226 10</b>	13	40 07157 50522 4
2/3	60 mm	1/4"	10	<b>061 236 10</b>	14	40 07157 30431 5

## 062 6,3 mm



**Industrie Umsteckbit 1/4" Phillips**  
*Industrial Reversible Bit 1/4" Phillips*



PH	—	⬮	⊞	Art.-Nr.	📦	EAN-Code
1/2	60 mm	1/4"	10	<b>062 126 10</b>	12	40 07157 30433 9
2/2	60 mm	1/4"	10	<b>062 226 10</b>	13	40 07157 50524 8
2/3	60 mm	1/4"	10	<b>062 236 10</b>	13	40 07157 30435 3

## 063 6,3 mm



**Industrie Umsteckbit 1/4" Phillips/Schlitz**  
*Industrial Reversible Bit 1/4" Phillips/Slotted*



PH	—	⬮	⊞	Art.-Nr.	📦	EAN-Code
5,5 PH2	60 mm	1/4"	10	<b>063 255 10</b>	12	40 07157 32556 3

## 070 C 8



**Industrie Bit C 8 Schlitz**  
*Industrial Bit C 8 Slotted*



⬮	⬮	—	⬮	⊞	Art.-Nr.	📦	EAN-Code
5,5 x 0,8	32 mm	C 8	5/16"	10	<b>070 514 10</b>	8	40 07157 30988 4
5,5 x 1,0	32 mm	C 8	5/16"	10	<b>070 524 10</b>	8	40 07157 30989 1
6,0 x 1,0	32 mm	C 8	5/16"	10	<b>070 604 10</b>	9	40 07157 30990 7
6,5 x 1,2	32 mm	C 8	5/16"	10	<b>070 614 10</b>	9	40 07157 30991 4
8,0 x 1,2	32 mm	C 8	5/16"	10	<b>070 804 10</b>	11	40 07157 30992 1
8,0 x 1,6	32 mm	C 8	5/16"	10	<b>070 814 10</b>	11	40 07157 30993 8
10,0 x 1,6	38 mm	C 8	5/16"	10	<b>070 104 10</b>	17	40 07157 30986 0
12,0 x 2,0	38 mm	C 8	5/16"	10	<b>070 204 10</b>	21	40 07157 30987 7

## 071 C 8



**Industrie Bit C 8 Pozidriv**  
*Industrial Bit C 8 Pozidriv*



PZ	—	⬮	⊞	Art.-Nr.	📦	EAN-Code	
1	32 mm	C 8	5/16"	10	<b>071 010 10</b>	9	40 07157 30994 5
2	32 mm	C 8	5/16"	10	<b>071 020 10</b>	10	40 07157 30995 2
3	32 mm	C 8	5/16"	10	<b>071 030 10</b>	11	40 07157 30996 9
4	38 mm	C 8	5/16"	10	<b>071 042 10</b>	17	40 07157 30997 6

## 072 C 8



### Industrie Bit C 8 Phillips

Industrial Bit C 8 Phillips



PH				Art.-Nr.		EAN-Code
1	32 mm	C 8	5/16"	10	<b>072 010 10</b>	9 40 07157 30998 3
2	32 mm	C 8	5/16"	10	<b>072 020 10</b>	10 40 07157 30999 0
3	32 mm	C 8	5/16"	10	<b>072 030 10</b>	10 40 07157 31000 2
4	38 mm	C 8	5/16"	10	<b>072 042 10</b>	16 40 07157 31001 9

## 074 C 8



### Industrie Bit C 8 Sechskant

Industrial Bit C 8 Hexagon



mm				Art.-Nr.		EAN-Code
3	32 mm	C 8	5/16"	10	<b>074 300 10</b>	10 40 07157 31003 3
4	32 mm	C 8	5/16"	10	<b>074 400 10</b>	10 40 07157 31004 0
5	32 mm	C 8	5/16"	10	<b>074 500 10</b>	11 40 07157 31005 7
6	32 mm	C 8	5/16"	10	<b>074 600 10</b>	12 40 07157 31006 4
8	32 mm	C 8	5/16"	10	<b>074 800 10</b>	13 40 07157 31007 1
10	32 mm	C 8	5/16"	10	<b>074 100 10</b>	20 40 07157 31002 6

## 076 C 8



### Industrie Bit C 8 TORX®

Industrial Bit C 8 TORX®



Torx®				Art.-Nr.		EAN-Code
25	32 mm	C 8	5/16"	10	<b>076 253 10</b>	10 40 07157 31008 8
27	32 mm	C 8	5/16"	10	<b>076 273 10</b>	10 40 07157 31009 5
30	32 mm	C 8	5/16"	10	<b>076 303 10</b>	11 40 07157 31010 1
40	32 mm	C 8	5/16"	10	<b>076 403 10</b>	11 40 07157 31011 8
45	32 mm	C 8	5/16"	10	<b>076 453 10</b>	12 40 07157 31012 5
50	32 mm	C 8	5/16"	10	<b>076 503 10</b>	13 40 07157 31013 2
55	32 mm	C 8	5/16"	10	<b>076 553 10</b>	18 40 07157 31014 9

## 078 C 8



### Industrie Bit C 8 XZN

Industrial Bit C 8 XZN



XZN				Art.-Nr.		EAN-Code
M 5	35 mm	C 8	5/16"	10	<b>078 050 10</b>	11 40 07157 50384 8
M 6	35 mm	C 8	5/16"	10	<b>078 060 10</b>	12 40 07157 50386 2
M 8	35 mm	C 8	5/16"	10	<b>078 080 10</b>	13 40 07157 50388 6
M10	35 mm	C 8	5/16"	10	<b>078 100 10</b>	17 40 07157 50390 9
M12	35 mm	C 8	5/16"	10	<b>078 120 10</b>	22 40 07157 50392 3

## 078 C 8



### Industrie Bit C 8 XZN lang

Industrial Bit C 8 XZN lang



XZN				Art.-Nr.		EAN-Code
M 5	120 mm	C 8	5/16"	10	<b>078 005 10</b>	27 40 07157 50394 7
M 6	120 mm	C 8	5/16"	10	<b>078 006 10</b>	48 40 07157 50396 1
M 8	120 mm	C 8	5/16"	10	<b>078 008 10</b>	45 40 07157 50398 5
M 10	120 mm	C 8	5/16"	10	<b>078 010 10</b>	71 40 07157 50400 5
M 12	120 mm	C 8	5/16"	10	<b>078 012 10</b>	95 40 07157 50402 9

## 081

Gewinde/  
Thread



### Gewindebit Pozidriv

Thread Bit Pozidriv



PZ				Art.-Nr.		EAN-Code
2	44,5 mm	M 5	6 mm 10	<b>081 020 10</b>	9	40 07157 31354 6
2	44,5 mm	10/32" NFA	6 mm 10	<b>081 025 10</b>	8	40 07157 31355 3

## 082

Gewinde/  
Thread



### Gewindebit Phillips

Thread Bit Phillips



PH				Art.-Nr.		EAN-Code
2	33 mm	M 5	6 mm 10	<b>082 020 20</b>	6	40 07157 53645 7
2	44,5 mm	M 5	6 mm 10	<b>082 020 10</b>	8	40 07157 31356 0
2	44,5 mm	M 6	8 mm 10	<b>082 225 10</b>	8	40 07157 62407 9
2	44,5 mm	10/32" NFA	6 mm 10	<b>082 025 10</b>	8	40 07157 31357 7

## 086

Gewinde/  
Thread



### Gewindebit TORX®

Thread Bit TORX®



Torx®				Art.-Nr.		EAN-Code
20	44,5 mm	M 5	6 mm 10	<b>086 200 10</b>	9	40 07157 31358 4
20	44,5 mm	M 5	6 mm 10	<b>086 250 10</b>	10	40 07157 31359 1
20	44,5 mm	M 6	8 mm 10	<b>086 020 10</b>	9	40 07157 63843 4
20	44,5 mm	M 6	8 mm 10	<b>086 025 10</b>	10	40 07157 63845 8

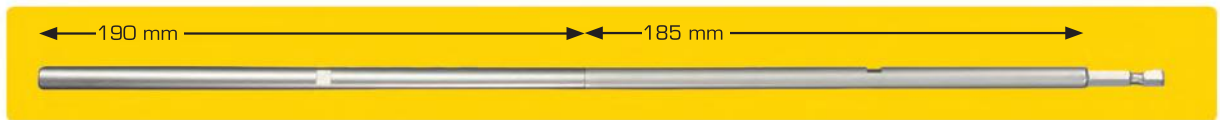

## 038

Gewinde/  
Thread

### Bit Adapter E 6,3 mit Innengewinde M 6

Bit Adapter E 6,3 with internal thread M 6

			Art.-Nr.		EAN-Code	
185 mm	M 6	8,5 mm	1	<b>038 200 10</b>	88	40 07157 63847 2



## 038

Gewinde/  
Thread

### Verlängerung für Bit Adapter mit Innengewinde M6 und Aussengewinde M6





Extension for Bit Adapter with internal thread M6 und external thread M6

			Art.-Nr.		EAN-Code	
200 mm	M 6	8,5 mm	1	<b>038 200 20</b>	81	40 07157 63849 6



## IMPACT Bit in Blister



IMPACT Bit blistered

						Art.-Nr.		EAN-Code
	2 x	IMPACT <b>PZ 1</b>	25 mm	C 6,3	10	<b>021 012 41</b>	13	40 07157 63001 8
	2 x	IMPACT <b>PZ 2</b>	25 mm	C 6,3	10	<b>021 022 41</b>	13	40 07157 63003 2
	2 x	IMPACT <b>PZ 3</b>	25 mm	C 6,3	10	<b>021 032 41</b>	15	40 07157 63005 6
	1 x	IMPACT <b>PZ 1</b>	50 mm	E 6,3	10	<b>031 015 41</b>	18	40 07157 63025 4
	1 x	IMPACT <b>PZ 2</b>	50 mm	E 6,3	10	<b>031 025 41</b>	18	40 07157 63027 8
	1 x	IMPACT <b>PZ 3</b>	50 mm	E 6,3	10	<b>031 035 41</b>	19	40 07157 63029 2
	2 x	IMPACT <b>PH 1</b>	25 mm	C 6,3	10	<b>022 012 41</b>	13	40 07157 62995 1
	2 x	IMPACT <b>PH 2</b>	25 mm	C 6,3	10	<b>022 022 41</b>	13	40 07157 62997 5
	2 x	IMPACT <b>PH 3</b>	25 mm	C 6,3	10	<b>022 032 41</b>	15	40 07157 62999 9
	1 x	IMPACT <b>PH 1</b>	50 mm	E 6,3	10	<b>032 015 41</b>	18	40 07157 63019 3
	1 x	IMPACT <b>PH 2</b>	50 mm	E 6,3	10	<b>032 025 41</b>	18	40 07157 63021 6
	1 x	IMPACT <b>PH 3</b>	50 mm	E 6,3	10	<b>032 035 41</b>	19	40 07157 63023 0
	2 x	IMPACT <b>Torx® 10</b>	25 mm	C 6,3	10	<b>026 102 41</b>	13	40 07157 63007 0
	2 x	IMPACT <b>Torx® 15</b>	25 mm	C 6,3	10	<b>026 152 41</b>	13	40 07157 63009 4
	2 x	IMPACT <b>Torx® 20</b>	25 mm	C 6,3	10	<b>026 202 41</b>	13	40 07157 63011 7
	2 x	IMPACT <b>Torx® 25</b>	25 mm	C 6,3	10	<b>026 252 41</b>	13	40 07157 63013 1
	2 x	IMPACT <b>Torx® 30</b>	25 mm	C 6,3	10	<b>026 302 41</b>	15	40 07157 63015 5
	2 x	IMPACT <b>Torx® 40</b>	25 mm	C 6,3	10	<b>026 402 41</b>	15	40 07157 63017 9
	1 x	IMPACT <b>Torx® 10</b>	50 mm	E 6,3	10	<b>036 105 41</b>	18	40 07157 63031 5
	1 x	IMPACT <b>Torx® 15</b>	50 mm	E 6,3	10	<b>036 155 41</b>	18	40 07157 63033 9
	1 x	IMPACT <b>Torx® 20</b>	50 mm	E 6,3	10	<b>036 205 41</b>	18	40 07157 63035 3
	1 x	IMPACT <b>Torx® 25</b>	50 mm	E 6,3	10	<b>036 255 41</b>	18	40 07157 63037 7
	1 x	IMPACT <b>Torx® 30</b>	50 mm	E 6,3	10	<b>036 305 41</b>	19	40 07157 63039 1
	1 x	IMPACT <b>Torx® 40</b>	50 mm	E 6,3	10	<b>036 405 41</b>	19	40 07157 63041 4



**Industrie Bit in Blister**  
Industrial Bit blistered



					Art.-Nr.		EAN-Code
2 x	<b>3,5 x 0,6</b>	25 mm C 6,3	10	<b>020 310 36</b>	13	40 07157 10263 8	
2 x	<b>4,0 x 0,8</b>	25 mm C 6,3	10	<b>020 410 36</b>	15	40 07157 10264 5	
2 x	<b>5,5 x 1,0</b>	25 mm C 6,3	10	<b>020 520 36</b>	15	40 07157 10265 2	
2 x	<b>6,5 x 1,2</b>	25 mm C 6,3	10	<b>020 610 36</b>	17	40 07157 10266 9	
2 x	<b>8,0 x 1,2</b>	25 mm C 6,3	10	<b>020 800 36</b>	19	40 07157 10267 6	
2 x	<b>PZ 1</b>	25 mm C 6,3	10	<b>021 010 36</b>	15	40 07157 10275 1	
2 x	<b>PZ 2</b>	25 mm C 6,3	10	<b>021 020 36</b>	15	40 07157 10276 8	
2 x	<b>PZ 3</b>	25 mm C 6,3	10	<b>021 030 36</b>	17	40 07157 10277 5	
3 x 1	<b>PZ 1 / PZ 2 / PZ 3</b>	25 mm C 6,3	10	<b>021 932 16</b>	21	40 07157 10281 2	
1 x	<b>PZ 4</b>	32 mm C 6,3	10	<b>021 042 36</b>	18	40 07157 51799 9	
2 x	<b>PZ 1</b>	50 mm E 6,3	10	<b>031 015 36</b>	28	40 07157 51637 4	
2 x	<b>PZ 2</b>	50 mm E 6,3	10	<b>031 025 36</b>	32	40 07157 10287 4	
3 x 1	<b>PZ 1 / PZ 2 / PZ 3</b>	50 mm E 6,3	10	<b>031 932 16</b>	41	40 07157 31306 5	
2 x	<b>PZ 2</b>	73 mm E 6,3	10	<b>031 027 36</b>	42	40 07157 10292 8	
2 x	<b>PH 1</b>	25 mm C 6,3	10	<b>022 010 36</b>	15	40 07157 10270 6	
2 x	<b>PH 2</b>	25 mm C 6,3	10	<b>022 020 36</b>	15	40 07157 10271 3	
2 x	<b>PH 3</b>	25 mm C 6,3	10	<b>022 030 36</b>	17	40 07157 10272 0	
3 x 1	<b>PH 1 / PH 2 / PH 3</b>	25 mm C 6,3	10	<b>022 931 16</b>	21	40 07157 10280 5	

## Industrie Bit in Blister

Industrial Bit blistered



					Art.-Nr.		EAN-Code
2 x	<b>PH 1</b>	50 mm	E 6,3	10	<b>032 015 36</b>	30	40 07157 51639 8
2 x	<b>PH 1</b>	73 mm	E 6,3	10	<b>032 017 36</b>	34	40 07157 50520 0
2 x	<b>PH 2</b>	50 mm	E 6,3	10	<b>032 025 36</b>	32	40 07157 10286 7
2 x	<b>PH 2</b>	73 mm	E 6,3	10	<b>032 027 36</b>	42	40 07157 10304 8
3 x 1	<b>PH 1 / PH 2 / PH 3</b>	50 mm	E 6,3	10	<b>032 931 16</b>	42	40 07157 31305 8
2 x	<b>2 mm</b>	25 mm	C 6,3	10	<b>024 200 36</b>	15	40 07157 31880 0
2 x	<b>2,5 mm</b>	25 mm	C 6,3	10	<b>024 250 36</b>	15	40 07157 31882 4
2 x	<b>3 mm</b>	25 mm	C 6,3	10	<b>024 300 36</b>	15	40 07157 31884 8
2 x	<b>4 mm</b>	25 mm	C 6,3	10	<b>024 400 36</b>	15	40 07157 31886 2
2 x	<b>5 mm</b>	25 mm	C 6,3	10	<b>024 500 36</b>	17	40 07157 10291 1
2 x	<b>6 mm</b>	25 mm	C 6,3	10	<b>024 600 36</b>	19	40 07157 10290 4
2 x	<b>8 mm</b>	25 mm	C 6,3	10	<b>024 800 36</b>	23	40 07157 31888 6
2 x	<b>Torx® 5</b>	25 mm	C 6,3	10	<b>026 050 36</b>	13	40 07157 52865 0
2 x	<b>Torx® 6</b>	25 mm	C 6,3	10	<b>026 060 36</b>	13	40 07157 10303 1
2 x	<b>Torx® 7</b>	25 mm	C 6,3	10	<b>026 070 36</b>	13	40 07157 10302 4
2 x	<b>Torx® 8</b>	25 mm	C 6,3	10	<b>026 080 36</b>	13	40 07157 10301 7
2 x	<b>Torx® 9</b>	25 mm	C 6,3	10	<b>026 090 36</b>	13	40 07157 10300 0
2 x	<b>Torx® 10</b>	25 mm	C 6,3	10	<b>026 100 36</b>	15	40 07157 10299 7
2 x	<b>Torx® 15</b>	25 mm	C 6,3	10	<b>026 150 36</b>	15	40 07157 10298 0
2 x	<b>Torx® 20</b>	25 mm	C 6,3	10	<b>026 200 36</b>	15	40 07157 10297 3
2 x	<b>Torx® 25</b>	25 mm	C 6,3	10	<b>026 250 36</b>	15	40 07157 10296 6
2 x	<b>Torx® 27</b>	25 mm	C 6,3	10	<b>026 270 36</b>	15	40 07157 10295 9
2 x	<b>Torx® 30</b>	25 mm	C 6,3	10	<b>026 300 36</b>	17	40 07157 10294 2
2 x	<b>Torx® 40</b>	25 mm	C 6,3	10	<b>026 400 36</b>	17	40 07157 22194 0
3 x 1	<b>Torx® 10 / Torx® 15 / Torx® 20</b>	25 mm	C 6,3	10	<b>026 931 16</b>	20	40 07157 32222 7
3 x 1	<b>Torx® 15 / Torx® 20 / Torx® 25</b>	25 mm	C 6,3	10	<b>026 933 16</b>	20	40 07157 52157 6
2 x	<b>Torx® 15</b>	50 mm	E 6,3	10	<b>036 155 36</b>	24	40 07157 51867 5
2 x	<b>Torx® 20</b>	50 mm	E 6,3	10	<b>036 205 36</b>	26	40 07157 51869 9
2 x	<b>Torx® 25</b>	50 mm	E 6,3	10	<b>036 255 36</b>	26	40 0715 751871 2
2 x	<b>Torx® 30</b>	50 mm	E 6,3	10	<b>036 305 36</b>	30	40 0715 751875 0
3 x 1	<b>Torx® 10 / Torx® 15 / Torx® 20</b>	50 mm	E 6,3	10	<b>036 931 16</b>	34	40 07157 52243 6
3 x 1	<b>Torx® 20 / Torx® 25 / Torx® 30</b>	50 mm	E 6,3	10	<b>036 932 16</b>	37	40 07157 52241 2





## 020

### Bit-Tool Industrie 10-tlg. geblisterert

Bit-Tool Industrial 10-pcs. blistered



		Art.-Nr.		EAN-Code
	10	<b>020 801 06</b>	152	40 07157 63427 6
(1 x) <b>020:</b>		5,5 x 1,0		
(1 x) <b>021:</b>		PZ 2		
(3 x) <b>022:</b>		PH 1 / PH 2 / PH 3		
(3 x) <b>026:</b>		Torx® 15 / Torx® 20 / Torx® 25		
(1 x) <b>038:</b>		<b>Bithalter</b> / <i>Bitholder</i> (58 mm)		





## 020

### Bit-Tool IMPACT 11-tlg. geblisterert

Bit-Tool IMPACT 11-pcs. blistered



		Art.-Nr.		EAN-Code
	10	<b>020 802 46</b>	193	40 07157 63429 0
(1 x) <b>026:</b>		Torx® 10		
(1 x) <b>026:</b>		Torx® 15		
(1 x) <b>026:</b>		Torx® 20		
(2 x) <b>026:</b>		Torx® 25		
(2 x) <b>026:</b>		Torx® 30		
(1 x) <b>026:</b>		Torx® 40		
(1 x) <b>038:</b>		<b>Bithalter</b> / <i>Bitholder</i> (58 mm)		
(1 x) <b>038:</b>		<b>IMPACT Bithalter</b> / <i>Bitholder</i>		



**Bit-Größen auf einen Blick • einfaches Entnehmen (Einhandbedienung) • Funktion als Hilfsschraubendreher**

*All sizes at one glance • easy selection of bits by pick and pull (one-hand operation) • auxiliary screwdriver function*





### 020

#### swift Bit-Box Industrie Universal, 7-tlg.

swift Bit-Box Industrial Universal, 7-pcs.





		Art.-Nr.		EAN-Code
	10	<b>020 601 16</b>	72	40 07157 51391 5
(2 x) <b>026:</b>	5,5 x 1,0 / 6,5 x 1,2			
(2 x) <b>026:</b>	PZ 1 / PZ 2			
(2 x) <b>026:</b>	PH 1 / PH 2			
(1 x) <b>038:</b>	Bithalter / Bitholder			

### 020

#### swift Bit-Box Industrie TORX®, 7-tlg.

swift Bit-Box Industrial TORX®, 7-pcs.





		Art.-Nr.		EAN-Code
	10	<b>020 603 16</b>	73	40 07157 51395 3
(6 x) <b>026:</b>	Torx® 10 / Torx® 15 / Torx® 20 / Torx® 25 / Torx® 30 / Torx® 40			
(1 x) <b>038:</b>	Bithalter / Bitholder			

### 020

#### swift Bit-Box Industrie PZ/PH, 7-tlg.

swift Bit-Box Industrial PZ/PH, 7-pcs.



		Art.-Nr.		EAN-Code
	10	<b>020 603 26</b>	72	40 07157 51689 3
(3 x) <b>021:</b>	PZ 1 / PZ 2 / PZ 3			
(3 x) <b>022:</b>	PH 1 / PH 2 / PH 3			
(1 x) <b>038:</b>	Bithalter / Bitholder			





## 020

### Bit-Box Industrie mit Gürtelclip, C 6,3 x 25 mm, 31-tlg.

*Bit-Box Industrial with belt clip, C 6,3 x 25 mm, 31-pcs.*





		Art.-Nr.		EAN-Code
	10	<b>020 131 16</b>	286	40 07157 64417 6
(30 x)	<b>Bits</b> C 6,3 x 25 mm			
	1x 0,6 x 4,5 / 1x 5,5 x 0,8 / 1x 6,5 x 1,2			
	2x PH 1 / 2x PH 2 / 1x PH 3 / 1x PZ 1 / 2x PZ 2 / 1x PZ 3			
	1x T 10 / 1x T 15 / 5x T 20 / 4x T 25 / 1x T 27 / 1x T 30 / 1x T 40			
	1x 3 mm / 1x 4 mm / 1x 5 mm / 1x 6 mm			
(1 x)	<b>Bithalter</b> / <i>Bitholder E 6,3 x 58 mm</i>			
	<b>Box</b>			



## 020

### Display Bit-Box Industrie 10 x Bit-Box Industrie mit Gürtelclip 31-tlg.

*Display Bit-Box Industrial 10 x Bit-Box Industrial with belt clip 31-pcs.*

		Art.-Nr.		EAN-Code
	1	<b>020 931 00</b>	2079	40 07157 64421 3
(10 x)	<b>Bit-Box mit Gürtelclip 31-tlg.</b> / <i>Bit-Box Industrial with belt clip, 31-pcs.</i>			





## 020



### Profi Bit-Box Industrie, C 6,3 x 25 mm, 13-tlg.

Profi Bit-Box Industrial,  
C 6,3 x 25 mm, 13-pcs.



		Art.-Nr.		EAN-Code
	10	<b>020 910 16</b>	107	40 07157 31405 5
(4 x) <b>020:</b>	4,0 x 0,8 / 5,5 x 1,0 / 6,5 x 1,2 / 8,0 x 1,2			
(2 x) <b>021:</b>	PZ 1 / PZ 3			
(2 x) <b>021:</b>	PZ 2			
(2 x) <b>022:</b>	PH 1 / PH 3			
(2 x) <b>022:</b>	PH 2			
(1 x) <b>038:</b>	<b>Bithalter</b> / Bitholder 58 mm			



## 022



### Profi Bit-Box Industrie, C 6,3 x 25 mm, 13-tlg.

Profi Bit-Box Industrial,  
C 6,3 x 25 mm, 13-pcs.



		Art.-Nr.		EAN-Code
	10	<b>022 910 16</b>	104	40 07157 31407 9
(2 x) <b>021:</b>	PZ 1			
(3 x) <b>021:</b>	PZ 2			
(1 x) <b>021:</b>	PZ 3			
(2 x) <b>022:</b>	PH 1			
(3 x) <b>022:</b>	PH 2			
(1 x) <b>022:</b>	PH 3			
(1 x) <b>038:</b>	<b>Bithalter</b> / Bitholder 58 mm			



## 026



### Profi Bit-Box Industrie, C 6,3 x 25 mm, 13-tlg.

Profi Bit-Box Industrial,  
C 6,3 x 25 mm, 13-pcs.



		Art.-Nr.		EAN-Code
	10	<b>026 910 16</b>	104	40 07157 31409 3
(10 x) <b>026:</b>	Torx® 6 / Torx® 7 / Torx® 8 / Torx® 9 / Torx® 10 / Torx® 15 / Torx® 20 / Torx® 27 / Torx® 30 / Torx® 40			
(2 x) <b>026:</b>	Torx® 25			
(1 x) <b>038:</b>	<b>Bithalter</b> / Bitholder 58 mm			

## 030



### Profi Bit-Box Industrie, E 6,3 x 50 mm, 6-tlg.

Profi Bit-Box Industrial,  
E 6,3 x 50 mm, 6-pcs.



Art.-Nr.



EAN-Code

10

030 915 16

78

40 07157 31410 9

(6 x) **030:** 3,0 x 0,5 / 3,5 x 0,6 / 4,0 x 0,8  
5,5 x 1,0 / 6,5 x 1,2 / 8,0 x 1,2

## 032



### Profi Bit-Box Industrie, E 6,3 x 50 mm, 6-tlg.

Profi Bit-Box Industrial,  
E 6,3 x 50 mm, 6-pcs.



Art.-Nr.



EAN-Code

10

032 915 16

78

40 07157 31412 3

(3 x) **031:** PZ 1 / PZ 2 / PZ 3  
(3 x) **032:** PH 1 / PH 2 / PH 3

## 036



### Profi Bit-Box Industrie, E 6,3 x 50 mm, 6-tlg.

Profi Bit-Box Industrial,  
E 6,3 x 50 mm, 6-pcs.



Art.-Nr.



EAN-Code

10

036 915 16

75

40 07157 31419 2

(6 x) **036:** Torx® 10 / Torx® 15 / Torx® 20  
Torx® 25 / Torx® 30 / Torx® 40

## 030



### Profi Bit-Box Industrie, E 6,3 x 50 mm, 6-tlg.

Profi Bit-Box Industrial,  
E 6,3 x 50 mm, 6-pcs.



Art.-Nr.



EAN-Code

10

030 925 16

75

40 07157 63075 9

(3 x) **030:** 3,0 x 0,5 / 4,0 x 0,8 / 5,5 x 1,0  
(1 x) **031:** PZ 2  
(2 x) **032:** PH 1 / PH 2

Sortimente für Elektriker /  
Assortments for Electricians

Sortimente für Elektriker /  
Assortments for Electricians



## 030

**Profi Bit-Box Industrie,  
E 6,3 x 73 mm, 6-tlg.**

*Profi Bit-Box Industrial,  
E 6,3 x 73 mm, 6-pcs.*



		Art.-Nr.		EAN-Code
	10	<b>030 927 16</b>	100	40 07157 63069 8
(3 x) <b>030:</b>	3,0 x 0,5 / 4,0 x 0,8 / 5,5 x 1,0			
(1 x) <b>031:</b>	PZ 2			
(2 x) <b>032:</b>	PH 1 / PH 2			

Sortimente für Elektriker /  
Assortments for Electricians



## 031

**Profi Bit-Box Industrie,  
E 6,3 x 73 mm, 6-tlg.**

*Profi Bit-Box Industrial,  
E 6,3 x 73 mm, 6-pcs.*



		Art.-Nr.		EAN-Code
	10	<b>031 927 16</b>	100	40 07157 63071 1
(3 x) <b>030:</b>	3,0 x 0,5 / 4,0 x 0,8 / 5,5 x 1,0			
(2 x) <b>031:</b>	Z(+/-) 1 / Z(+/-) 2			
(1 x) <b>032:</b>	PH 2			

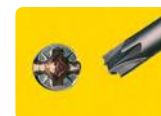

Sortimente für Elektriker /  
Assortments for Electricians



## 032

**Profi Bit-Box Industrie,  
E 6,3 x 73 mm, 6-tlg.**

*Profi Bit-Box Industrial,  
E 6,3 x 73 mm, 6-pcs.*



		Art.-Nr.		EAN-Code
	10	<b>032 927 16</b>	100	40 07157 63073 5
(3 x) <b>030:</b>	3,0 x 0,5 / 4,0 x 0,8 / 5,5 x 1,0			
(2 x) <b>031:</b>	(+/-) 1 / H(+/-) 2			
(1 x) <b>032:</b>	PH 2			





## 030



### Profi Bit-Box Industrie, E 6,3 x 73 mm, 5-tlg.

Profi Bit-Box Industrial,  
E 6,3 x 73 mm, 5-pcs.



		Art.-Nr.		EAN-Code
	10	<b>030 917 16</b>	83	40 07157 31411 6
(5 x) <b>030:</b>	3,0 x 0,5 / 3,5 x 0,6 / 4,0 x 0,8 5,5 x 1,0 / 6,5 x 1,2			



## 032



### Profi Bit-Box Industrie, E 6,3 x 73 mm, 6-tlg.

Profi Bit-Box Industrial,  
E 6,3 x 73 mm, 6-pcs.



		Art.-Nr.		EAN-Code
	10	<b>032 917 16</b>	112	40 07157 31385 0
(3 x) <b>031:</b>	PZ 1 / PZ 2 / PZ 3			
(3 x) <b>032:</b>	PH 1 / PH 2 / PH 3			



## 036



### Profi Bit-Box Industrie, E 6,3 x 73 mm, 6-tlg.

Profi Bit-Box Industrial,  
E 6,3 x 73 mm, 6-pcs.



		Art.-Nr.		EAN-Code
	10	<b>036 917 16</b>	100	40 07157 31417 8
(6 x) <b>036:</b>	Torx® 10 / Torx® 15 / Torx® 20 Torx® 25 / Torx® 30 / Torx® 40			



**Super-starke Umschaltmechanik mit Feinverzahnung  
(>65Nm, 60 Zähne, 6° Rückholwinkel)**

*Super strong ratcheting mechanism with fine toothing  
(>65 Nm, 60 teeth, 6° ratcheting angle)*



**Mit Bit-Direktaufnahme –  
extrem niedrige Kopfhöhe!**

*Direct fit for bits =  
extreme low operating height*

**Leicht abgewinkelter Griff erleichtert  
das Arbeiten und schützt die Finger**

*Slightly angled handle makes work  
more comfortable and protects  
the fingers*

## XS Werkzeugsatz / tool set



**Ratsche einteilig aus Chrom  
Vanadium Stahl geschmiedet**

*Ratchet forged in one piece from  
chrom-vanadium steel*

**Verschiedene anwendungsgerechte  
Sortimente in der stabilen,  
spritzwassergeschützten mini  
StrongBox**

*Practice oriented assortments  
stored in robust, splashproof  
mini StrongBox*

**Hochwertig und langlebig:  
15 Jahre Garantie auf jedes Stück**

*Long lasting premium quality  
in every detail:  
15 years guarantee on every  
component*





## 057



### XS 18 - Werkzeugsatz 1/4" mit Miniratsche, Bits, Steckschlüsselinsätzen und Zubehör in XS-Strongbox, 18-tlg.

XS 18 - tool set 1/4" with mini ratchet, bits, sockets and accessories in XS-Strongbox, 18-pcs.



Art.-Nr.



EAN-Code

057 718 06

420

40 07157 61561 9

**Miniratsche 1/4" / Mini Ratchet 1/4"**

(7 x) **Steckschlüsselinsätze / Sockets**  
5 / 5,5 / 6 / 7 / 8 / 10 / 13 mm

(7 x) **Bits** (C6,3 x 25 mm)

PH 1 / PH 2 / PH 3

PZ 2

Torx® 15 / Torx® 20 / Torx® 25

**Verlängerung / Extension** (50 mm) 1/4" - 1/4"

**Adapter / Adapter C** 6,3 - 1/4" (25 mm)

**Bithalter / Bitholder** E6,3 x 58 mm

**XS-Strongbox**

## 057



### XS 23 - Werkzeugsatz 1/4" mit Miniratsche, Steckschlüsselinsätzen und Zubehör in XS-Strongbox, 23-tlg.

XS 23 - tool set 1/4" with mini ratchet, sockets and accessories in XS-Strongbox, 23-pcs.



Art.-Nr.



EAN-Code

057 723 06

423

40 07157 64197 7

**Miniratsche 1/4" / Mini Ratchet 1/4"**

(5 x) **Steckschlüsselinsätze / Sockets**  
6 / 7 / 8 / 10 / 13 mm

(15 x) **Bits** (C6,3 x 25 mm)

4 / 5 / 6 mm

PH 1 / PH 2 / PH 3

PZ 1 / PZ 2 / PZ 3

Torx® 10 / Torx® 15 / Torx® 20 / Torx® 25 / Torx® 30 / Torx® 40

**Adapter / Adapter C** 6,3 - 1/4" (25 mm)

**Bithalter / Bitholder** E6,3 x 58 mm

**XS-Strongbox**

## 057



### XS 33 - Werkzeugsatz 1/4" mit Miniratsche, Bits und Zubehör in XS-Strongbox, 33-tlg.

*XS 33 - tool set 1/4" with mini ratchet, bits and accessories in XS-Strongbox, 33-pcs.*

Art.-Nr.



EAN-Code

057 733 06

425

40 07157 61545 9

**Miniratsche 1/4" / Mini Ratchet 1/4"**

(30 x)

**Bits (C6,3 x 25 mm)**

3,0 x 0,5 / 4,0 x 0,8 / 6,5 x 1,2

2 / 2,5 / 3 / 4 / 5 / 6 / 8 mm

PH 0 / PH 1 / 2 x PH 2 / PH 3

PZ 1 / 2 x PZ 2 / PZ 3

Torx® 6 / Torx® 7 / Torx® 8 / Torx® 9

Torx® TR 10 H / Torx® TR 15 H / Torx® TR 20 H / Torx® TR 25 H / Torx® TR 27 H / Torx® TR 30 H / Torx® TR 40 H

**Adapter / Adapter C 6,3 - 1/4" (25 mm)**

**Bithalter / Bitholder E6,3 x 58 mm**

**XS-Strongbox**

## 057



### XS 18 Inch - Werkzeugsatz 1/4" mit Miniratsche, Bits, Steckschlüsseleinsätzen Inch und Zubehör in XS-Strongbox, 18-tlg.

*XS 18 Inch - tool set 1/4" with mini ratchet, bits, sockets Inch and accessories in XS-Strongbox, 18-pcs.*

Art.-Nr.



EAN-Code

057 718 56

420

40 07157 62059 0

**Miniratsche 1/4" / Mini Ratchet 1/4"**

(7 x)

**Steckschlüsseleinsätze / Sockets**

3/16" | 7/32" | 1/4" | 9/32" | 5/16" | 3/8" | 1/2"

(7 x)

**Bits (C6,3 x 25 mm)**

4,0 x 0,8 / 5,5 x 1,0 / 6,5 x 1,2

PH 1 / PH 2 / PH 3

SQ 2

**Verlängerung / Extension (50 mm) 1/4" - 1/4"**

**Adapter / Adapter C 6,3 - 1/4" (25 mm)**

**Bithalter / Bitholder E6,3 x 58 mm**

**XS-Strongbox**



## 020

### XS-Strongbox Bits 30, 30-tlg.

XS-Strongbox bits 30, 30-pcs.



1/4"

	Art.-Nr.		EAN-Code
	<b>020 730 06</b>	334	40 07157 61563 3
(28 x)	<b>Bits C 6,3 x 25 mm</b>		
	3,0 x 0,5 / 4,0 x 0,8 / 5,5 x 1,0 / 6,5 x 1,2		
	PH 0 / PH 1 / PH 2 / PH 3 / PZ 1 / PZ 2 / PZ 3		
	2 mm / 3 mm / 4 mm / 5 mm / 6 mm		
	Torx® 5 / Torx® 6 / Torx® 7 / Torx® 8 / Torx® 10 / Torx® 15 / Torx® 20 / Torx® 25 / Torx® 30 / Torx® 40		
	Spanner 6 / Spanner 8		
	<b>ERGONIC Stubby 1/4"</b>		
	<b>Bithalter / Bitholder E 6,3 x 58 mm</b>		
	<b>XS-Strongbox</b>		



## 020

### XS-Strongbox Security, 30-tlg.

XS-Strongbox Security, 30-pcs.



1/4"

	Art.-Nr.		EAN-Code
	<b>020 730 16</b>	340	40 07157 51565 0
	<b>Bits C 6,3 x 25 mm</b>		
024	2,0 / 2,5 / 3,0 / 4,0 mm		
028	XZN M 6 / XZN M 5 / XZN M 4		
029	TS 10 / TS 8 / TS 6 / TS 4 / TS 2 / TS 0		
027	TORX® TR 30 H / TR 25 H / TR 20 H / TR 15 H / TR 10 H		
029	Tri-Wing 5 / 4 / 3 / 2 / 1		
020	Spanner 6 / 8 / 10		
028	Clutch 5/32", 1/4"		
	<b>ERGONIC Stubby 1/4"</b>		
	<b>Bithalter / Bitholder E 6,3 x 58 mm</b>		
	<b>XS-Strongbox</b>		

## 020



1/4"

### XS-Strongbox Bits 38, 38-tlg.

XS-Strongbox bits 38, 38-pcs.



Art.-Nr.



EAN-Code

**020 738 06**

346

40 07157 61565 7

[36 x]	<b>Bits</b> C 6,3 x 25 mm
	5,5 x 1,0 / 6,5 x 1,2
	2 mm / 3 mm / 4 mm / 5 mm / 6 mm
	2 x PZ 1 / 5 x PZ 2 / 2 x PZ 3
	PH 0 / 2 x PH 1 / 4 x PH 2 / 2 x PH 3
	Torx® 6 / Torx® 7 / Torx® 8 / Torx® 10 / Torx® 15 / Torx® 20 / Torx® 25 / Torx® 30 / Torx® 40
	SQ 1 / SQ 2
	<b>Felo Star Automatischer Bithalter</b> / Felo Star Automatic-Holder
	<b>Bithalter</b> / Bitholder E6,3 x 58 mm
	<b>XS-Strongbox</b>

## 020



1/4"

### XS-Strongbox AllStar 21-tlg.

XS-Strongbox AllStar, 21-pcs.



Art.-Nr.



EAN-Code

**020 821 36**

262

40 07157 64945 4

[20 x]	<b>Bits</b>
	5,5 x 1,0 / 6,5 x 1,2
	3 x PZ 2 / 1 x PZ 3
	3 x PH 2 / 1 x PH
	3 x Torx® 20 / 3 x Torx® 25 / 3 x Torx® 30 / 1 x Torx® 40
	<b>Star Bithalter</b> / Star Bitholder
	<b>XS-Strongbox</b>





## 020

### XS-Strongbox Bits 35, 35-tlg.

XS-Strongbox bits 35, 35-pcs.



Art.-Nr.



EAN-Code

020 735 16

365

40 07157 61567 1

[28 x]	<b>Bits C 6,3 x 25 mm</b> 4,0 x 0,8 / 5,5 x 1,0 / 6,5 x 1,2 3 mm / 4 mm / 5 mm PH 0 / 2 x PH 1 / 2 x PH 2 / PH 3 2 x PZ 1 / 3 x PZ 2 / PZ 3 Torx® 5 / Torx® 6 / Torx® 7 / Torx® 8 / Torx® 10 / Torx® 15 / Torx® 20 / Torx® 25 / Torx® 30 / Torx® 40
[6 x]	<b>Bits E 6,3 x 50 mm</b> PZ 1 / PZ 2 PH 2 Torx® 20 / Torx® 25 / Torx® 30
	<b>Bithalter / Bitholder E6,3 x 58 mm</b>
	<b>XS-Strongbox</b>



## 020

### XS-Strongbox Bits 35 TORX®, 35-tlg.

XS-Strongbox bits 35 TORX®, 35-pcs.



Art.-Nr.



EAN-Code

020 735 26

365

40 07157 63529 7

[28 x]	<b>Bits C 6,3 x 25 mm</b> 1 x Torx® 5 / 1 x Torx® 6 / 1 x Torx® 7 / 1 x Torx® 8 / 1 x Torx® 9 2 x Torx® 10 / 4 x Torx® 15 / 4 x Torx® 20 / 4 x Torx® 25 1 x Torx® 27 / 4 x Torx® 30 / 4 x Torx® 40
[6 x]	<b>Bits E 6,3 x 50 mm</b> Torx® 10 / Torx® 15 / Torx® 20 / Torx® 25 / Torx® 30 / Torx® 40
	<b>Bithalter / Bitholder E6,3 x 58 mm</b>
	<b>XS-Strongbox</b>





## 020

### XS-Strongbox IMPACT Pro, 19-tlg.

*XS-Strongbox IMPACT Pro,  
19-pcs.*



Art.-Nr.



EAN-Code

**020 719 46**

262

40 07157 63187 9

[18 x]	<b>IMPACT Bits</b> C6,3 x 25 mm
	1 x PZ 1 / 2 x PZ 2 / 2 x PZ 3
	1 x PH 1 / 2 x PH 2 / 2 x PH 3
	1 x Torx® 10 / 1 x Torx® 15 / 1 x Torx® 20
	2 x Torx® 25 / 2 x Torx® 30 / 1 x Torx® 40
	<b>Bithalter IMPACT</b> / <i>Bitholder IMPACT</i> E6,3 x 58 mm
	<b>XS-Strongbox</b>



## 020

### XS-Strongbox IMPACT, 19-tlg.

*XS-Strongbox IMPACT,  
19-pcs.*



Art.-Nr.



EAN-Code

**020 719 06**

260

40 07157 63555 6

[18 x]	<b>Industrial Bits</b> C6,3 x 25 mm
	1 x PZ 1 / 2 x PZ 2 / 2 x PZ 3
	1 x PH 1 / 2 x PH 2 / 2 x PH 3
	1 x Torx® 10 / 1 x Torx® 15 / 1 x Torx® 20
	2 x Torx® 25 / 2 x Torx® 30 / 1 x Torx® 40
	<b>Bithalter IMPACT</b> / <i>Bitholder IMPACT</i> E6,3 x 58 mm
	<b>XS-Strongbox</b>





**Optimal in engen Toleranzen gezogene  
Sechskant-Profil**

*Optimal hexagon shape, precision formed*

**durch spezielle Beschichtung  
bis zu 30% höherer  
Rostschutz**

*30% increased anti-rust  
protection due to unique  
coating*

## Sechskant-Schlüssel

*Hexagon Key  
Products*

**sorgfältige Vergütung  
garantiert optimale Härte  
und Elastizität**

*Careful tempering guarantees  
optimum hardness and  
elasticity*

**matt vernickelt  
Oberfläche**

*nickel-plated surface*

**extra lange Ausführung  
für extra Hebelwirkung**

*Extra long arm for  
maximum leverage*

**Kugelkopf**

*ballend*

# 348

## Fähnenschlüssel TORX®

Flagdriver TORX®



Torx®			∅		Art.-Nr.		EAN-Code
5	33	19	2,5	3	<b>348 105 50</b>	3	40 07157 53317 3
6	33	19	2,5	3	<b>348 106 50</b>	3	40 07157 53319 7
7	33	19	2,5	3	<b>348 107 50</b>	4	40 07157 53321 0
8	33	19	2,5	3	<b>348 108 50</b>	4	40 07157 53323 4
9	37	24	3,0	3	<b>348 109 50</b>	5	40 07157 53325 8
10	37	24	3,0	3	<b>348 110 50</b>	6	40 07157 53327 2
15	43	28	4,0	3	<b>348 115 50</b>	8	40 07157 53329 6
20	43	28	4,0	3	<b>348 120 50</b>	11	40 07157 53331 9

# 348

## Fähnenschlüsselsatz TORX®, 7-tlg. inkl. Halter

Flagdriverset TORX®,  
7-pcs. incl. holder



Torx®	Art.-Nr.		EAN-Code
	<b>348 907 50</b>	71	40 07157 60393 7
(7x ) <b>348:</b> Torx® 6 / Torx® 7 / Torx® 8 / Torx® 9 Torx® 10 / Torx® 15 / Torx® 20			

# 349

## Fähnenschlüssel TORX PLUS®

Flagdriver TORX PLUS®



Torx Plus®			∅		Art.-Nr.		EAN-Code
5 IP	33	19	2,5	3	<b>349 105 50</b>	3	40 07157 53333 3
6 IP	33	19	2,5	3	<b>349 106 50</b>	3	40 07157 53335 7
7 IP	33	19	2,5	3	<b>349 107 50</b>	4	40 07157 53337 1
8 IP	33	19	2,5	3	<b>349 108 50</b>	4	40 07157 53339 5
9 IP	37	24	3,0	3	<b>349 109 50</b>	5	40 07157 53341 8
10 IP	37	24	3,0	3	<b>349 110 50</b>	6	40 07157 53343 2
15 IP	43	28	4,0	3	<b>349 115 50</b>	8	40 07157 53345 6
20 IP	43	28	4,0	3	<b>349 120 50</b>	11	40 07157 53347 0

## 349

### Fähnenschlüsselsatz TORX PLUS®, 7-tlg. inkl. Halter



Flagdriverset TORX PLUS®,  
7-pcs. incl. holder



Torx Plus®	Art.-Nr.		EAN-Code
	<b>349 907 50</b>	71	40 07157 60395 1
[7x] <b>349:</b> 6 IP / 7 IP / 8 IP / 9 IP / 10 IP / 15 IP / 20 IP			

## 345

### Winkelschlüssel Sechskant kurz



Hex-Key short



			Art.-Nr.		EAN-Code	
<b>1,5 mm</b>	46,5	1,5	10	<b>345 015 10</b>	1	40 07157 64967 6
<b>2,0 mm</b>	52,0	2,0	10	<b>345 020 10</b>	2	40 07157 64969 0
<b>2,5 mm</b>	58,5	2,5	10	<b>345 025 10</b>	4	40 07157 64971 3
<b>3,0 mm</b>	66,0	3,0	10	<b>345 030 10</b>	5	40 07157 64973 7
<b>3,5 mm</b>	69,5	3,5	10	<b>345 035 10</b>	8	40 07157 64975 1
<b>4,0 mm</b>	74,0	4,0	10	<b>345 040 10</b>	10	40 07157 64977 5
<b>4,5 mm</b>	80,0	4,5	10	<b>345 045 10</b>	15	40 07157 64979 9
<b>5,0 mm</b>	85,0	5,0	10	<b>345 050 10</b>	18	40 07157 64981 2
<b>6,0 mm</b>	96,0	6,0	10	<b>345 060 10</b>	30	40 07157 64983 6
<b>7,0 mm</b>	102,0	7,0	10	<b>345 070 10</b>	43	40 07157 64985 0
<b>8,0 mm</b>	108,0	8,0	10	<b>345 080 10</b>	59	40 07157 64987 4
<b>9,0 mm</b>	114,0	9,0	10	<b>345 090 10</b>	79	40 07157 64989 8
<b>10 mm</b>	122,0	10,0	10	<b>345 100 10</b>	103	40 07157 64991 1
<b>11 mm</b>	129,0	11,0	5	<b>345 110 10</b>	131	40 07157 64993 5
<b>12 mm</b>	137,0	12,0	5	<b>345 120 10</b>	160	40 07157 64995 9
<b>13 mm</b>	145,0	13,0	5	<b>345 130 10</b>	215	40 07157 64997 3
<b>14 mm</b>	154,0	14,0	5	<b>345 140 10</b>	260	40 07157 64999 7
<b>17 mm</b>	177,0	17,0	5	<b>345 170 10</b>	430	40 07157 65001 6
<b>19 mm</b>	199,0	19,0	1	<b>345 190 10</b>	620	40 07157 65003 0
<b>22 mm</b>	222,0	22,0	1	<b>345 220 10</b>	950	40 07157 65005 4
<b>24 mm</b>	248,0	24,0	1	<b>345 240 10</b>	1250	40 07157 65007 8
<b>27 mm</b>	277,0	27,0	1	<b>345 270 10</b>	1740	40 07157 65009 2

## 345

### Winkelschlüsselsatz Sechskant kurz, vernickelt, 7-tlg. auf Clip



Hex Key set short, nickel plated,  
7-pcs. on clip



	Art.-Nr.		EAN-Code
	<b>345 007 11</b>	80	40 07157 65011 5
1,5 mm / 2,0 mm / 2,5 mm / 3,0 mm / 4,0 mm / 5,0 mm / 6,0 mm			



# 346



## Winkelschlüssel Sechskant extra lang, vernickelt

Hex Key extra long, nickel plated



				Art.-Nr.		EAN-Code
1,5 mm	91,5	1,5	10	<b>346 015 10</b>	2	40 07157 65013 9
2,0 mm	102,0	2,0	10	<b>346 020 10</b>	4	40 07157 65015 3
2,5 mm	114,5	2,5	10	<b>346 025 10</b>	6	40 07157 65017 7
3,0 mm	129,0	3,0	10	<b>346 030 10</b>	9	40 07157 65019 1
4,0 mm	144,0	4,0	10	<b>346 040 10</b>	19	40 07157 65021 4
5,0 mm	165,0	5,0	10	<b>346 050 10</b>	33	40 07157 65023 8
6,0 mm	186,0	6,0	10	<b>346 060 10</b>	54	40 07157 65025 2
8,0 mm	208,0	8,0	10	<b>346 080 10</b>	105	40 07157 65027 6
10,0 mm	234,0	10,0	10	<b>346 100 10</b>	185	40 07157 65029 0



# 346



## Winkelschlüsselsatz Sechskant extra lang, vernickelt, 9-tlg. auf Clip

Felo Winkelschlüssel Sechskant, extra lang Set 9-tlg. HEX 1,5 - 10 mm

		Art.-Nr.		EAN-Code
1,5 mm / 2,0 mm / 2,5 mm / 3,0 mm / 4,0 mm 5,0 mm / 6,0 mm / 8,0 mm / 10,0 mm		<b>346 009 11</b>	430	40 07157 65031 3

## 348

### Winkelschlüssel TORX® lang, vernickelt



Angle Wrench TORX® long, nickel plated



Torx®		∅		Art.-Nr.		EAN-Code
6	44,5	2,5	10	<b>348 006 10</b>	2	40 07157 65033 7
7	50,5	2,5	10	<b>348 007 10</b>	2	40 07157 65035 1
8	51,0	3,0	10	<b>348 008 10</b>	3	40 07157 65037 5
9	51,0	3,0	10	<b>348 009 10</b>	3	40 07157 65039 9
10	54,0	3,0	10	<b>348 010 10</b>	4	40 07157 65041 2
15	57,5	3,5	10	<b>348 015 10</b>	5	40 07157 65043 6
20	61,0	4,0	10	<b>348 020 10</b>	7	40 07157 65045 0
25	64,5	4,5	10	<b>348 025 10</b>	10	40 07157 65047 4
27	69,5	5,5	10	<b>348 027 10</b>	15	40 07157 65049 8
30	76,0	6,0	10	<b>348 030 10</b>	20	40 07157 65051 1
40	83,0	7,0	10	<b>348 040 10</b>	30	40 07157 65053 5
45	91,0	8,0	10	<b>348 045 10</b>	43	40 07157 65055 9
50	104,0	9,0	10	<b>348 050 10</b>	65	40 07157 65057 3

## 348

### Winkelschlüsselsatz TORX® lang, vernickelt, 8-tlg. auf Clip



Angle Wrench set TORX® long, nickel plated, 8-pcs. on clip



	Art.-Nr.		EAN-Code
5	<b>348 888 11</b>	160	40 07157 65059 7
Torx® 9 / Torx® 10 / Torx® 15 / Torx® 20 / Torx® 25 / Torx® 27 / Torx® 30 / Torx® 40			

## 348

### Winkelschlüsselsatz TORX® mit Kugelkopf lang, vernickelt, 8-tlg. auf Clip



Angle Wrench set TORX® with ballend long, nickel plated, 8-pcs. on clip



	Art.-Nr.		EAN-Code
5	<b>348 080 11</b>	270	40 07157 65061 0
Torx® 9 / Torx® 10 / Torx® 15 / Torx® 20 / Torx® 25 / Torx® 27 / Torx® 30 / Torx® 40			

# 365



## Winkelschlüssel Sechskant mit Kugelkopf lang, vernickelt

Hex Key with ballend long, nickel plated



				Art.-Nr.		EAN-Code
<b>1,5 mm</b>	91,5	1,5	10	<b>365 015 10</b>	2	40 07157 65063 4
<b>2,0 mm</b>	102,0	2,0	10	<b>365 020 10</b>	4	40 07157 65065 8
<b>2,5 mm</b>	114,5	2,5	10	<b>365 025 10</b>	6	40 07157 65067 2
<b>3,0 mm</b>	129,0	3,0	10	<b>365 030 10</b>	9	40 07157 65069 6
<b>4,0 mm</b>	144,0	4,0	10	<b>365 040 10</b>	19	40 07157 65071 9
<b>5,0 mm</b>	165,0	5,0	10	<b>365 050 10</b>	33	40 07157 65073 3
<b>6,0 mm</b>	186,0	6,0	10	<b>365 060 10</b>	54	40 07157 65077 1
<b>8,0 mm</b>	208,0	8,0	10	<b>365 080 10</b>	105	40 07157 65079 5
<b>10,0 mm</b>	234,0	10,0	10	<b>365 100 10</b>	185	40 07157 65081 8



# 365



## Winkelschlüsselsatz Sechskant mit Kugelkopf lang, vernickelt, 9-tlg. auf Clip

Hex Key set with ballend long, nickel plated, 9-pcs. on clip



		Art.-Nr.		EAN-Code
	5	<b>365 009 11</b>	430	40 07157 65083 2
1,5 mm / 2,0 mm / 2,5 mm / 3,0 mm / 4,0 mm				
5,0 mm / 6,0 mm / 8,0 mm / 10,0 mm				





## 375 Winkelschlüsselsatz Sechskant Inch mit Kugelkopf lang, vernickelt, 13-tlg. auf Clip



Hex Key set Inch with ballend long, nickel plated, 13-pcs. on clip





			Art.-Nr.		EAN-Code
		5	<b>375 130 11</b>	430	40 07157 65085 6
.050"	1/16"	5/64"	3/32"	7/64"	1/8"
9/64"	5/32"	3/16"	7/32"	1/4"	5/16"
				3/8"	



## 345 Handklapphalter Sechskant, 6-tlg.



Fold Up Hexagon, 6-pcs.

			Art.-Nr.		EAN-Code
		5	<b>345 007 21</b>	175	40 07157 65087 0
2,5 mm / 3,0 mm / 4,0 mm					
5,0 mm / 6,0 mm / 8,0 mm					





**>felo**

**made in  
Germany**  
since 1878

[www.felo.com](http://www.felo.com)





# Verkaufs- und Lieferbedingungen

Nachstehende Lieferbedingungen gelten durch Auftragserteilung als vereinbart. Hiervon abweichende Vereinbarungen werden erst durch unsere schriftliche Bestätigung gültig. Sie heben den übrigen Teil der Verkaufs- und Lieferungsbedingungen nicht auf.

## 1. Angebot und Vertragsabschluss

Unsere Angebote sind freibleibend, Verträge und sonstige Vereinbarungen werden erst durch unsere schriftliche Bestätigung oder durch unsere Lieferung/Leistung verbindlich. Sämtliche Vereinbarungen zwischen uns und unseren Kunden sind bei Vertragsabschluss schriftlich niederzulegen. Bei oder nach Vertragsabschluss getroffene Vereinbarungen zwischen unseren Mitarbeitern oder Vertretern und unseren Kunden bedürfen zu ihrer Gültigkeit unserer schriftlichen Bestätigung; die Vertretungsmacht unserer Mitarbeiter und Vertreter ist insoweit eingeschränkt.

Ergänzungen, Änderungen oder Nebenabreden bedürfen ebenfalls der Schriftform. Dies gilt auch für die Aufhebung des Schriftformerfordernisses.

## 2. Lieferverpflichtung

Voraussetzung für die Lieferpflicht ist die unbedingte Kreditwürdigkeit des Kunden. Werden die Zahlungsbedingungen nicht eingehalten oder werden Umstände bekannt, die die Kreditwürdigkeit des Kunden ernsthaft in Frage stellen oder wird ein Scheck nicht eingelöst, so werden sämtliche offen stehende Forderungen fällig. Nach fruchtlosem Ablauf einer von uns gesetzten Nachfrist, auch ohne Kündigungsandrohung, sind wir berechtigt, den Vertrag schriftlich zu kündigen und die Lieferungen einzustellen sowie alle bisher erbrachten Lieferungen abzubrechen.

Teillieferungen sind zulässig.

Bei Sonderanfertigungen behalten wir uns eine Mehr- oder Minderlieferung von 10% vor, auch für den Fall, dass Teillieferungen bereits erfolgten oder noch erfolgen.

Bestellungen auf Abruf sind, wenn nichts anderes schriftlich vereinbart ist, spätestens innerhalb von einem viertel Jahr nach Ablauf der Vertragsfrist abzunehmen, ohne dass wir die Abnahme unter Fristsetzung anmahnen. Nach Ablauf dieser 3 Monate sind wir berechtigt, nach unserer Wahl entweder die Ware in Rechnung zu stellen oder den Auftrag zu streichen.

Störungen und Ereignisse höherer Gewalt berechtigen uns, die eingegangene Lieferfrist für die Dauer der Betriebsverhinderung und einer angemessenen Anlaufzeit zu verlängern. Unter Umständen können auch unsere Lieferverpflichtungen ganz oder teilweise aufgehoben werden. Dies gilt auch, wenn uns die Lieferung unmöglich geworden ist, ohne dass wir dieses zu vertreten haben.

Der Kunde kann von uns dann die Erklärung verlangen, ob wir zurücktreten oder innerhalb angemessener Frist liefern. Die Geltendmachung von Ersatzansprüchen in irgendwelcher Art infolge verspäteter Lieferung ist auf einen Maximalwert von 5% des Auftragswertes beschränkt.

## 3. Lieferzeit

Die Lieferzeit ist eingehalten, wenn bis zu ihrem Ablauf die Versandbereitschaft mitgeteilt ist, oder der Liefergegenstand das Werk verlassen hat.

Der in der Auftragsbestätigung genannte Termin ist freibleibend, wenn nicht eine gesonderte schriftliche Lieferzusicherung erfolgt ist.

## 4. Preise

Unsere Preise beruhen auf den zum Zeitpunkt der Auftragsannahme gültigen Kalkulationsunterlagen. Lieferungen, die später als 4 Monate nach Vertragsabschluss erbracht werden, berechtigen uns, z.B. bei Lohn- und/oder Materialpreiserhöhungen, eine Anpassung der Preise bis zu maximal 5% vorzunehmen.

## 5. Transport

Die Wahl des Transportweges und der Transportmittel erfolgt nach bestem Ermessen ohne Haftung für den billigsten Weg. Sofern uns besondere Vorschriften ergehen werden, erfolgt der Versand entsprechend.

Das Transportrisiko trägt in jedem Fall der Empfänger, auch dann, wenn die Lieferung frei Empfangsort oder FOB eines Schiffes vereinbart wird.

Mit Verlassen des Werkes wird die Ware als bedingungsgemäß geliefert betrachtet, auch wenn sie unmittelbar an Dritte gesandt wird.

## 6. Eigentumsvorbehalt

Die gelieferte Ware bleibt bis zur Erfüllung aller uns aus der gegenseitigen Geschäftsbeziehung zustehenden Ansprüchen unser Eigentum.

Der Kunde darf die in unserem Eigentum stehende Waren weder an Dritte verpfänden noch zur Sicherheit übereignen.

Bei Pfändung der in unserem Eigentum stehenden Ware ist der Kunde verpflichtet, uns sofort zu benachrichtigen und zwar unter Vorlegung der Pfändungspapiere und einer eidesstattlichen Versicherung, aus der hervorgeht, dass die Ware unser Eigentum ist. Die Kosten für eine evtl. notwendig werdende Intervention trägt der Kunde.

Der Kunde ist berechtigt, die gelieferte Ware im ordnungsgemäßen Geschäftsgang weiter zu veräußern. Im Falle der Weiterveräußerung tritt an die Stelle der gelieferten Ware der Anspruch des Kunden an seinen Abnehmer, der bis zur Höhe unserer gesamten Forderungen schon jetzt als an uns abgetreten gilt. Der Kunde ist zur Einziehung der Forderung bis auf Widerruf berechtigt. Auf Verlangen ist der Kunde verpflichtet, die Abtretung den Drittschuldnern mitzuteilen und uns die zur Geltendmachung unserer Rechte erforderlichen Auskünfte zu geben und Unterlagen auszuhandigen. Die Abtretung der Forderungen wird von selbst hinfällig, sobald der Kunde die Kaufpreisschuld bzw. alle Verbindlichkeiten aus laufender Geschäftsverbindung beglichen hat.

Ist der Eigentumsvorbehalt oder die Abtretung nach dem Recht, in dessen Bereich sich die Ware befindet, nicht wirksam, so gilt die dem Eigentumsvorbehalt und der Abtretung in diesem Bereich entsprechende Sicherung als vereinbart. Ist zur Entstehung solcher Rechte die Mitwirkung des Kunden erforderlich, so ist er auf unsere Anforderung hin verpflichtet, alle Maßnahmen zu treffen, die zur Begründung und Erhaltung solcher Rechte erforderlich sind.

## 7. Zahlung

Für die Zahlung sind unsere jeweiligen Bedingungen maßgebend. Abzüge jeder Art ohne die entsprechende Vereinbarung sind unzulässig. Eingereichte Schecks gelten erst nach vollständiger Einlösung als Zahlung.

Bei Überschreitung der Zahlungsfrist werden vom Fälligkeitstag an unter Vorbehalt der Geltendmachung weiteren Verzugschadens Verzugszinsen berechnet. Der berechnete Zinssatz beträgt 9%.

Gerät der Kunde mit seiner Zahlung in Verzug, so steht uns das Recht zu, sofortige Zahlung aller offenen, auch noch nicht fälligen Forderungen oder eine Herausgabe der gelieferten Ware bis zur vollständigen Begleichung unserer Forderung zu verlangen.

## 8. Gewährleistung

Beanstandungen über Menge und Qualität können nur angenommen und geprüft werden, wenn sie schriftlich innerhalb von 14 Tagen nach Eingang der Ware am Bestimmungsort vorgenommen werden. Waren, die wir als fehlerhaft anerkennen, nehmen wir zurück und liefern dafür Ersatz. Weiter Ansprüche des Kunden können wir nicht anerkennen.

## 9. Erfüllungsort und Gerichtsstand

Erfüllungsort ist 35279 Neustadt Kreis Marburg, Gerichtsstand - ohne Rücksicht auf die Höhe des Objektes das Landgericht Marburg/Lahn. Maßgebend ist das deutsche Recht.

## 10. Salvatorische Klausel

Sollten Bestimmungen dieses Vertrages unwirksam, unvollständig oder undurchführbar sein, so bleiben die übrigen Bestimmungen unverändert gültig. In diesem Falle soll eine Regelung gefunden werden, die im Rahmen des gesetzlich Zulässigen wirtschaftlich dem am nächsten kommt, was die Parteien gewollt haben oder gewollt haben würden, wenn sie diesen Punkt bedacht hätten.

Alle Preise zzgl. der gesetzlichen Mehrwertsteuer. Eine Haftung für Fehler oder Irrtümer in diesem Katalog wird hiermit ausgeschlossen. Änderungen sind jederzeit ohne Vorankündigung möglich.

# Terms of Sale and Delivery

The following terms of delivery shall be considered as agreed upon at order placement. Deviating agreements shall only obtain validity by our written confirmation. The deviating agreements shall not rescind the remaining terms of sale and delivery.

## 1. Quotation and Conclusion of Contract

Our quotations shall be without engagement. Contracts and other agreements shall only become binding through our written confirmation or our performance. All agreements between us and our customers shall be concluded in writing at conclusion of contract. Agreements made between our employees or representatives and our customers during or subsequent to contract conclusion shall only become valid with our written confirmation; the power of attorney held by our employees or representatives shall be limited in this respect.

Supplements, modifications or additional agreements also require the written form. This shall also apply to rescinding the requirement of the written form.

## 2. Delivery Commitment

The customer's unconditional creditworthiness shall be a prerequisite for delivery commitment. Should the terms of payment not be adhered to or circumstances become known which seriously put the customer's creditworthiness into question or if a cheque is not honoured, all receivables become due. On failure of payment within an adequate period of grace set by us, even if devoid of a threat of termination, we shall be entitled to withdraw from the contract in writing and discontinue deliveries and cease all previously performed deliveries.

Partial deliveries are admissible.

We reserve the right to 10% over or short delivery for custom-made products, this also applies in case partial deliveries have already been made or are yet to be made.

If nothing else has been agreed upon in writing, orders on call must be purchased within three months of expiry of the contractual deadline, without us having to send a reminder containing an explicit purchase deadline. After these three months have expired, we shall optionally be entitled to either invoice the goods or cancel the order.

Disruptions and force majeure incidents entitle us to extend the agreed delivery period for the duration of the operative hindrance and a reasonable start-up period. As the case may be our delivery commitments may also be revoked partially or completely. This also applies if it has become impossible for us to deliver at no fault of ours. The customer may then demand our statement as to whether we want to withdraw from delivery or deliver within a reasonable deadline. Compensation claims of any kind resulting from late delivery are limited to 5% of the order value.

## 3. Delivery Period

The delivery period shall be deemed as adhered to if readiness for shipment has been notified or the object of delivery has left the manufacturing company before expiry of the delivery period.

The deadline mentioned in the order confirmation is without engagement unless a separate written delivery affirmation has been issued.

## 4. Prices

Our prices are based on the calculation documents applicable at the time of order acceptance. Deliveries which are performed later than four months after conclusion of contract entitle us to adjust the prices by maximally 5%, e.g. in case of wage increases or increases in material prices.

## 5. Transport

The choice of the route or means of transport is made according to best judgement with no liability for the cheapest route. As far as particular specifications have been provided to us, shipping shall proceed accordingly.

The risk of transport shall in any case be borne by the receiver, even if delivery 'free at destination' or FOB a ship has been agreed.

On departure from the manufacturing company the goods shall be regarded as delivered according to agreement, even if they are delivered directly to third parties.

## 6. Reservation of Title

We reserve the title for the delivered goods until all our rightful claims resulting from our mutual business relationship have been fulfilled.

The customer may neither pledge the goods which are in our property, nor convey them as collateral to third parties.

On the seizure of goods which are our property the customer shall be committed to notify us of this immediately and furthermore present us with the seizure documents as well as an affidavit showing that the goods are our property. The expenses for a possibly required intervention shall be borne by the customer.

The customer shall be entitled to resell the delivered goods in the regular course of business. In case of a resale, the customer's claim towards the sub purchaser, which is already considered as assigned to us up to the amount of our total receivables, shall replace the delivered goods. The customer is entitled to collect the receivables until such title is revoked. Upon request the customer is committed to notify the garnishees of such assignment and disclose to us any information and hand out any documents to us required in order to protect our rights. The assignment of the receivables shall lapse as soon as the customer has honoured the debt resulting from the purchase price and/or all debt resulting from the current business relationship.

Should reservation of title or assignment be invalid according to the jurisdiction in the area where the goods are located, the collateral which applies in that area ensuring reservation of title and assignment shall be considered agreed. Should the customer's cooperation be necessary for the origination of such rights, customer shall be committed to take all measures required in order to constitute and preserve such rights.

## 7. Payment

Our respective terms are applicable to payment. Deductions of any kind without a respective agreement are prohibited. Cheques that have been handed in shall only be considered as payment after their full encashment.

On exceeding the payment deadline default interests shall be charged as of the due date, subject to any claim for further default damages. The charged default interest rate is 9%.

In the event that the customer enters into default with their payment, we have the right to demand immediate payment of all arrears including those which have not yet entered into default, or release of the delivered goods until complete payment of our receivables.

## 8. Warranty

Complaints concerning quantity and quality can only be accepted and examined if made in writing within 14 days after receipt of the goods at the place of destination. Goods which we acknowledge as being defective will be taken back and replaced. Any additional claims by the customer shall not be recognised by us.

## 9. Place of Performance and Jurisdiction, Language

Place of performance shall be 35279 Neustadt Kreis Marburg, Federal Republic of Germany. Place of Jurisdiction - notwithstanding the amount of the subject - shall be the Marburg / Lahn district court. German Law shall prevail. Contract language shall be German. In case of dissent the German version shall prevail.

## 10. Severability Clause

Should any provision of this agreement be or become invalid, ineffective or unenforceable, the validity, effectiveness and enforceability of the remaining provisions shall not be affected thereby. In such event a provision must be found that comes as closest to the legally permitted economic intent and purpose of what the parties had or would have intended had they considered the aspect.

Liability for errors or mistakes in this catalog is hereby excluded. Changes are possible at any time without notice.



Felo Werkzeugfabrik GmbH  
Industriestraße 2  
35279 Neustadt (Hessen)

Tel.: +49 6692 - 88 0  
Fax: +49 6692 - 88 99  
info@felo.com  
www.felo.com